

HONDA
MARINE

BF15D/BF20D/BFP15D/BFP20D
Owner's Manual





WARNING:



The engine exhaust from this product contains chemicals known to the State of California to cause cancer, birth defects, or other reproductive harm.

Keep this owner's manual handy, so you can refer to it at any time. This owner's manual is considered a permanent part of the outboard motor and should remain with the outboard motor if resold.

The information and specifications included in this publication were in effect at the time of approval for printing. Honda Motor Co., Ltd. reserves the right, however, to discontinue or change specifications or design at any time without notice and without incurring any obligation whatever. No part of this publication may be reproduced without written permission.

Congratulations on your selection of a Honda outboard motor. We are certain you will be pleased with your purchase of one of the finest outboard motors on the market.

We want to help you get the best results from your new outboard motor and to operate it safely. This manual contains the information on how to do that; please read it carefully.

As you read this manual you will find information preceded by a

NOTICE symbol. That information is intended to help you avoid damage to your outboard motor, other property, or the environment.

We suggest you read the warranty policy to fully understand its coverage and your responsibilities of ownership. The warranty policy is a separate document that should have been given to you by your dealer.

When your outboard motor needs scheduled maintenance, keep in mind that your Honda marine dealer is specially trained in servicing Honda outboard motors. Your Honda marine dealer is dedicated to your satisfaction and will be pleased to answer your questions and concerns.

© 2003 Honda Motor Co., Ltd. All Rights Reserved

INTRODUCTION

A FEW WORDS ABOUT SAFETY

Your safety and the safety of others are very important. And using this outboard motor safely is an important responsibility.



To help you make informed decisions about safety, we have provided operating procedures and other information on labels and in this manual. This information alerts you to potential hazards that could hurt you or others.

Of course, it is not practical or possible to warn you about all the hazards associated with operating or maintaining an outboard motor. You must use your own good judgment.

You will find important safety information in a variety of forms, including:

- **Safety Labels** — on the outboard motor.
- **Safety Messages** — preceded by a safety alert symbol  and one of three signal words, DANGER, WARNING, or CAUTION.

These signal words mean:

- | | |
|---|---|
|  | You WILL be KILLED or SERIOUSLY HURT if you don't follow instructions. |
|  | You CAN be KILLED or SERIOUSLY HURT if you don't follow instructions. |
|  | You CAN be HURT if you don't follow instructions. |

- **Safety Headings** — such as *IMPORTANT SAFETY INFORMATION*.
- **Safety Section** — such as *OUTBOARD MOTOR SAFETY*.
- **Instructions** — how to use this outboard motor correctly and safely.

This entire book is filled with important safety information — please read it carefully.

CONTENTS

OUTBOARD MOTOR SAFETY.....	7	Manual Relief Valve (T type).....	22
IMPORTANT SAFETY INFORMATION.....	7	Tilt Lock Lever (G and T types).....	23
SAFETY LABEL LOCATIONS.....	9	Common Controls	
CONTROLS AND FEATURES.....	10	Engine Cover Latch.....	23
CONTROL AND FEATURE		Transom Angle Adjusting Rod.....	23
IDENTIFICATION CODES.....	10	Tilt Lever (except G and T types).....	24
COMPONENT AND CONTROL LOCATIONS.....	12	INSTRUMENTS.....	24
CONTROLS.....	15	Fuel Gauge.....	24
H Type (tiller handle)		Tachometer (optional equipment).....	24
Engine Stop Switch and Switch Clip.....	15	INDICATORS.....	25
Choke Knob (H type manual choke).....	15	Oil Pressure Indicator (R type) (H type).....	25
Throttle Grip.....	16	Overheating Indicator (R type).....	25
Throttle Friction Adjuster.....	16	Cooling System Indicator.....	26
Gearshift Lever.....	16	OTHER FEATURES.....	26
Recoil Starter Grip.....	17	Overrev Limiter.....	26
Electric Starter Button		Automatic Choke	
(models equipped with electric starter).....	17	(models equipped with electric starter).....	26
Steering Friction Lever.....	17	Anodes.....	26
Power Tilt Switch (T type).....	18	Portable Fuel Tank.....	27
Tilt Lever (G type).....	18	Fuel Cap Vent Knob.....	27
R Type (remote control)		Fuel Priming Bulb.....	27
Ignition Switch.....	19		
Switch Clip and Emergency Stop Switch.....	19		
Fast Idle Lever.....	20		
Gearshift/Throttle Control Lever.....	21		
Power Tilt Switch (T type).....	22		

CONTENTS

INSTALLATION.....	28	PORTABLE FUEL TANK.....	37
POWER REQUIREMENTS.....	28	FUEL HOSE CONNECTIONS.....	37
BOAT TRANSOM REQUIREMENTS.....	28	FUEL PRIMING.....	38
INSTALLATION POSITION.....	28	STARTING THE ENGINE.....	38
ATTACHMENT.....	29	H Type (tiller handle).....	38
TRANSOM ANGLE ADJUSTMENT.....	30	R Type (remote control).....	41
BATTERY CONNECTIONS.....	30	EMERGENCY STARTING.....	43
BEFORE OPERATION.....	33	STOPPING THE ENGINE.....	46
ARE YOU READY TO GET UNDER WAY ?.....	33	Emergency Engine Stopping.....	46
IS YOUR OUTBOARD MOTOR		Normal Engine Stopping.....	46
READY TO GO ?.....	33	GEARSHIFT AND	
OPERATION.....	35	THROTTLE OPERATION.....	48
SAFE OPERATING PRECAUTIONS.....	35	H Type (tiller handle).....	48
BREAK-IN PROCEDURE.....	35	R Type (remote control).....	49
TRANSOM ANGLE ADJUSTMENT.....	36	STEERING.....	50
		H Type (tiller handle).....	50
		R Type (remote control).....	50
		CRUISING.....	51
		SHALLOW WATER OPERATION.....	54
		MOORING, BEACHING, LAUNCHING.....	57

CONTENTS

SERVICING YOUR OUTBOARD MOTOR	59	STORAGE	80
THE IMPORTANCE OF MAINTENANCE.....	59	STORAGE PREPARATION	80
MAINTENANCE SAFETY	60	Cleaning and Flushing	80
TOOL KIT AND EMERGENCY STARTER		Fuel.....	82
ROPE.....	61	Engine Oil	84
MAINTENANCE SCHEDULE	62	STORAGE PRECAUTIONS	84
MANUAL RELIEF VALVE (T type).....	64	REMOVAL FROM STORAGE.....	85
ENGINE COVER REMOVAL AND			
INSTALLATION.....	64	TRANSPORTING	86
Engine Oil Level Check.....	65	WITH OUTBOARD MOTOR INSTALLED	
Engine Oil Change	66	ON BOAT	86
Oil Filter Change.....	67	WITH OUTBOARD MOTOR REMOVED	
Engine Oil Recommendations	68	FROM BOAT	86
Gear Oil Level Check.....	68		
Gear Oil Change.....	69		
Lubrication Points	71		
Spark Plug Service	72		
REFUELING.....	74		
FUEL RECOMMENDATIONS.....	75		
Fuel Pump Filter Inspection and Replacement.....	75		
Portable Fuel Tank and Filter Cleaning	77		
Recoil Starter Rope Inspection	78		
Anode Replacement	78		
Propeller Replacement	79		

CONTENTS

TAKING CARE OF UNEXPECTED PROBLEMS.....	87
BATTERY WILL NOT CHARGE AND ELECTRIC STARTER WILL NOT OPERATE..	92
OIL PRESSURE INDICATOR LIGHT GOES OFF AND ENGINE SPEED IS LIMITED.....	93
OVERHEATING INDICATOR LIGHT COMES ON AND ENGINE SPEED IS LIMITED (remote control type).....	94
SUBMERGED MOTOR	95
TECHNICAL AND CONSUMER INFORMATION...	97
TECHNICAL INFORMATION.....	97
Serial Number locations.....	97
Carburetor Modification for High Altitude Operation.....	98
Oxygenated Fuels.....	99
Emission Control System Information	100
Star Label	102
Specifications	104
CONSUMER INFORMATION	108
INDEX.....	109
WIRING DIAGRAMS	113

This Owner's Manual is using the following type names when it describes the operations special to a type.

Tiller handle type: H type
Remote control type: R type
Gas-assisted type: G type
Power tilt type: T type

Check the type of your outboard motor and read this Owner's Manual thoroughly before operation. Texts with no type indication are the information and/or procedures common to all types.

OUTBOARD MOTOR SAFETY

IMPORTANT SAFETY INFORMATION

Honda BF15D/BFP15D/BF20D and BFP20D outboard motors are designed for use with boats that have a suitable manufacturer's power recommendation. Other uses can result in injury to the operator or damage to the outboard motor and other property.

Most accidents can be prevented if you follow all instructions in this manual and on the outboard motor. The most common hazards are discussed below, along with the best way to protect yourself and others.

Operator Responsibility

- It is the operator's responsibility to provide the necessary safeguards to protect people and property. Know how to stop the engine quickly in case of emergency. Understand the use of all controls.
- Stop the engine immediately if anyone falls overboard, and do not run the engine while the boat is near anyone in the water.
- Always stop the engine if you must leave the controls for any reason.
- Attach the emergency stop switch lanyard securely to the operator.
- Always wear a PFD (Personal Flotation Device) while on the boat.
- Familiarize yourself with all laws and regulations relating to boating and the use of outboard motors.
- Be sure that anyone who operates the outboard motor receives proper instruction.
- Be sure the outboard motor is properly mounted on the boat.
- Do not remove the engine cover while the engine is running.

OUTBOARD MOTOR SAFETY

Refuel With Care

- Gasoline is extremely flammable, and gasoline vapor can explode. Refuel outdoors, in a well-ventilated area, with the engine stopped. Never smoke near gasoline, and keep other flames and sparks away.
- Remove any portable fuel tank from the boat for refueling. Keep the portable fuel tank away from the battery or other potential spark sources.
- Refuel carefully to avoid spilling fuel. Avoid overfilling the fuel tank.
- After refueling, tighten the filler cap securely. If any fuel is spilled, make sure the area is dry before starting the engine.

Carbon Monoxide Hazard

Exhaust gas contains poisonous carbon monoxide. Avoid inhalation of exhaust gas. Never run the engine in a closed garage or confined area.

SAFETY LABEL LOCATIONS

WARNING
PRESSURIZED GAS
DO NOT PUNCTURE
OR INCINERATE.

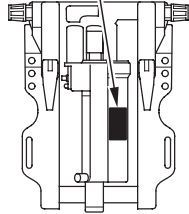

READ OWNER'S MANUAL CAREFULLY
BEFORE OPERATION

WARNING

- PLACE TRANSMISSION IN NEUTRAL BEFORE STARTING.
- DO NOT OPERATE WITH ENGINE COVER REMOVED.
- BE SURE THE ANTIVENTILATION PLATE IS BELOW THE WATER LINE.
- DO NOT SHIFT TO REVERSE SUDDENLY AT HIGH SPEED.
- CHECK OIL LEVEL BEFORE STARTING.
- FLUSH THE SYSTEM THOROUGHLY WITH FRESH WATER AFTER EACH USE IN SALT WATER.
- EMERGENCY STARTING INSTRUCTIONS ARE ON TOP OF ENGINE.

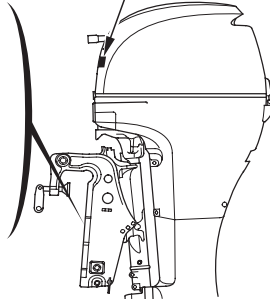

EMERGENCY STARTING

READ OWNER'S MANUAL.

1. REMOVE RECOIL STARTER.
2. HOLD RECOIL SELECTOR IN N (NEUTRAL).
3. KEEP RECOIL ROPE FLOWING.

WARNING

MOVING PARTS CAN INJURE YOU.
 KEEP AWAY FROM ENGINE WHILE PULLING ROPE.
 KEEP AWAY FROM ENGINE AFTER STARTING ENGINE.

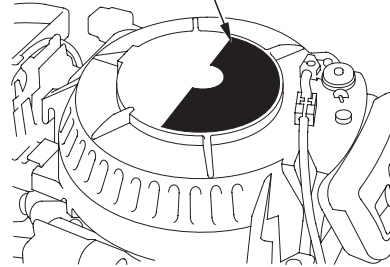

GASOLINE **FLAMMABLE DANGER**

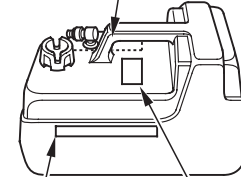

DANGER

HARMFUL OR FATAL IF SWALLOWED.
 KEEP OUT OF REACH OF CHILDREN.
 IF SWALLOWED, DO NOT INDUCE
 VOMITING. CALL A PHYSICIAN
 IMMEDIATELY.

GASOLINE **FLAMMABLE DANGER**

The labels shown here contain important safety information. Please read them carefully. These labels are considered permanent parts of your outboard motor. If a label comes off or becomes hard to read, contact an authorized Honda Marine servicing dealer for a replacement.

CONTROLS AND FEATURES

CONTROL AND FEATURE IDENTIFICATION CODES

Model	BF15D															BFP15D		
	SHA	LHA	XHA	SHSA	LHSA	LRA	LGA	SHGA	LHGA	XHGA	LHTA	SRTA	SHTA	LRTA	XHTA	LRTA	XRTA	
Shaft Length	S	L	X	S	L	L	L	S	L	X	L	S	L	L	X	L	X	
Tiller Handle	H	H	H	H	H		H	H	H	H	H		H		H			
Remote Control						R						R		R		R	R	
Electric Starter				S	S	S		S	S	S	S	S	S	S	S	S	S	
Gas-assisted Tilt							G	G	G	G								
Power Tilt											T	T	T	T	T	T	T	
Power Thrust Propeller															P	P	P	
Battery Charging DC Receptacle	●	●	●				●											
Tachometer						*						*		*		*	*	

Refer to this chart for an explanation of the Type Codes used in this manual to identify control and feature applications.

BF15D/BFP15D are provided with the following types according to the shaft length, control system, tilt system, and start system.

- Shaft Length
S: Short Shaft
L: Long Shaft
X: Extra Long Shaft

- Control System
H: Tiller Handle Control
R: Remote Control
- Tilt system
G : Gas-assisted Tilt (with gas damper assist function)
T : Power Tilt (with hydraulic assist function)

- * : Optional Equipment
- : Standard Equipment

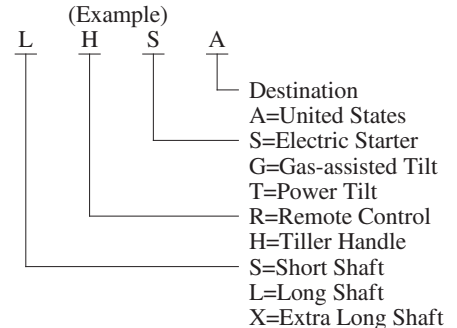

Model	BF20D																BFP20D
	SHA	LHA	SHSA	LHSA	XHSA	SRA	LRA	LGA	SHGA	LHGA	XHGA	SHTA	LHTA	XHTA	SRTA	LRTA	
Shaft Length	S	L	S	L	X	S	L	L	S	L	X	S	L	X	S	L	L
Tiller Handle	H	H	H	H	H			H	H	H	H	H	H	H			
Remote Control						R	R								R	R	R
Electric Starter			S	S	S	S	S		S	S	S	S	S	S	S	S	S
Gas-assisted Tilt								G	G	G	G						
Power Tilt												T	T	T	T	T	T
Power Thrust Propeller																	P
Battery Charging DC Receptacle	●	●						●									
Tachometer						*	*								*	*	*

Refer to this chart for an explanation of the Type Codes used in this manual to identify control and feature applications.

BF20D/BFP20D are provided with the following types according to the shaft length, control system, tilt system, and start system.

- Shaft Length
S: Short Shaft
L: Long Shaft
X: Extra Long Shaft

- Control System
H: Tiller Handle Control
R: Remote Control
- Tilt system
G : Gas-assisted Tilt (with gas damper assist function)
T : Power Tilt (with hydraulic assist function)

- * : Optional Equipment
- : Standard Equipment

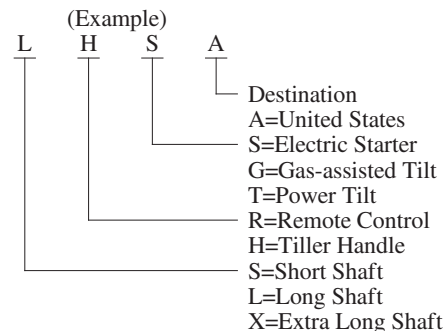

CONTROLS AND FEATURES

COMPONENT AND CONTROL LOCATIONS

H Type (tiller handle)

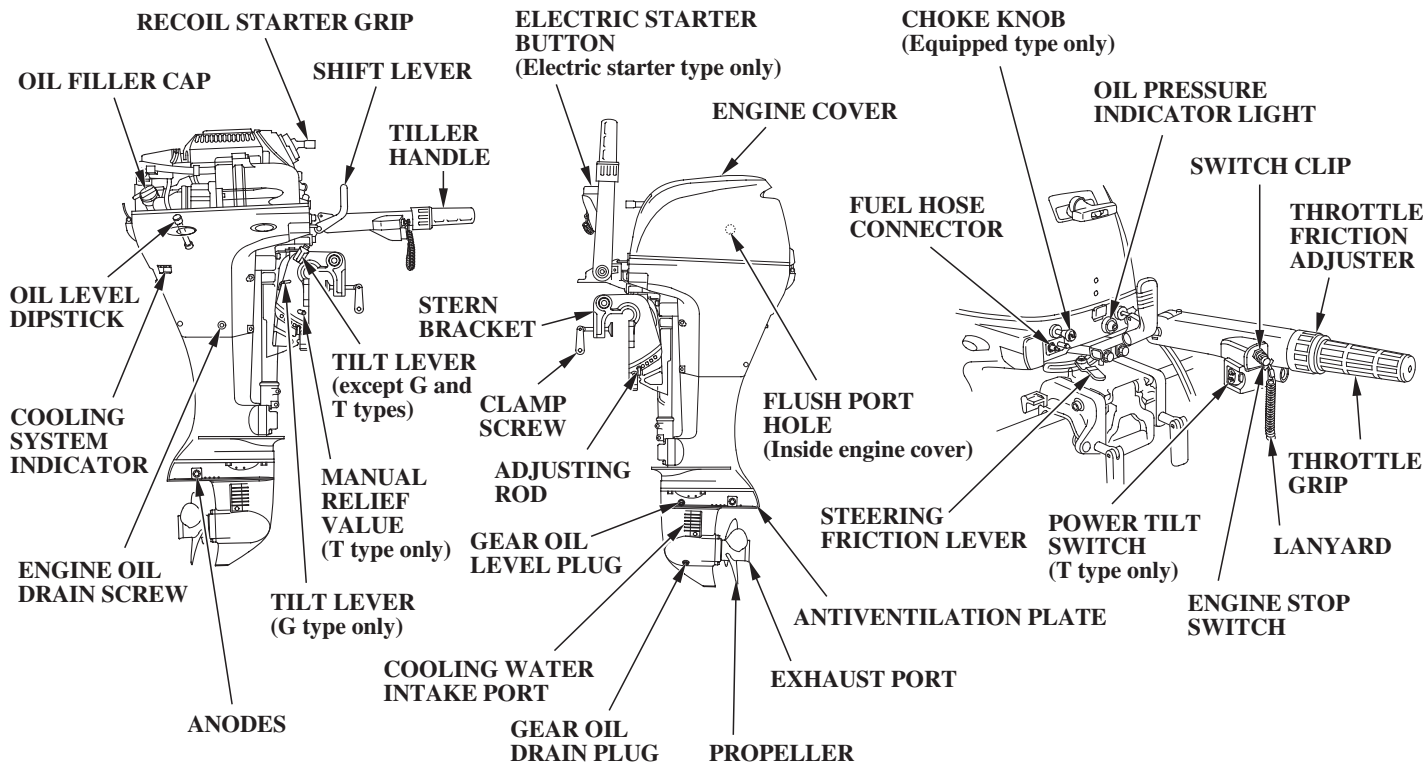

CONTROLS AND FEATURES

R Type (remote control)

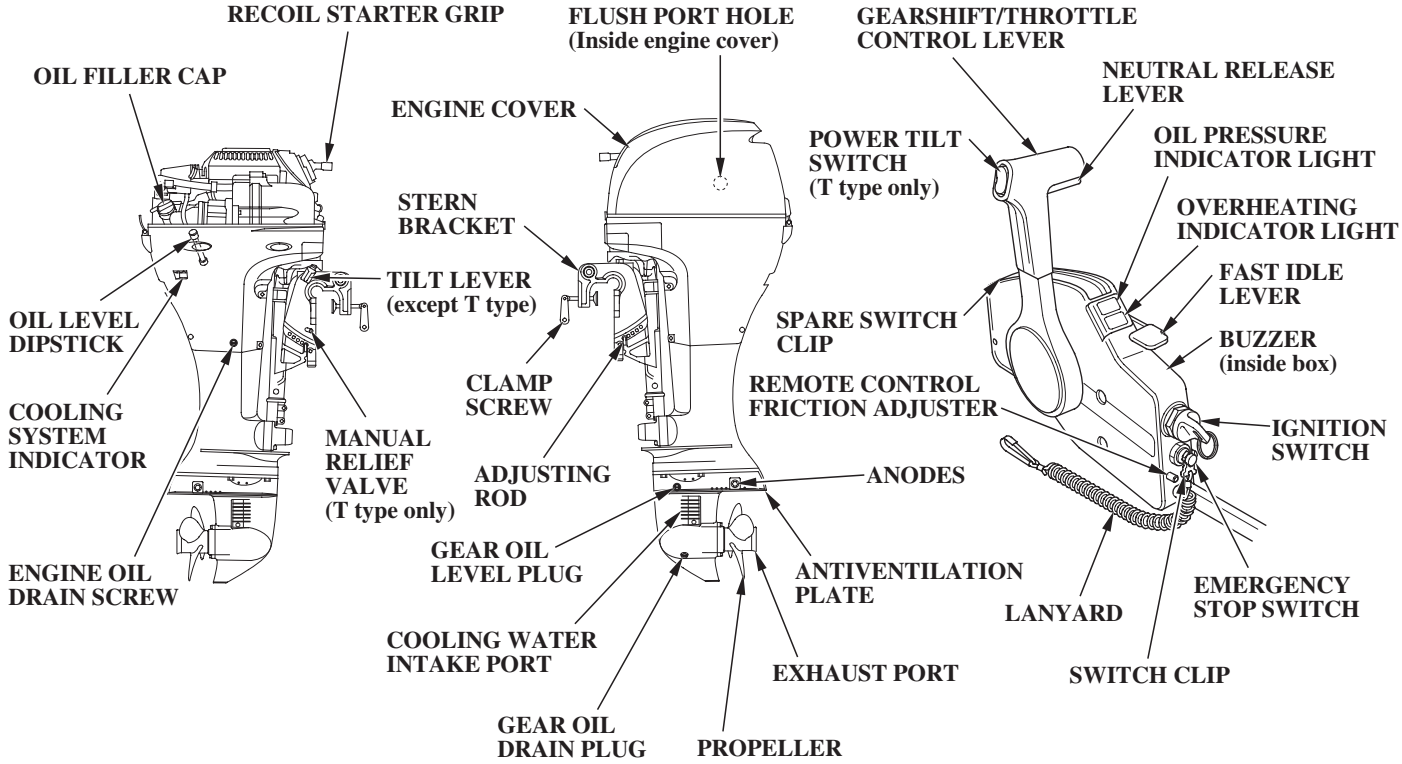

CONTROLS AND FEATURES

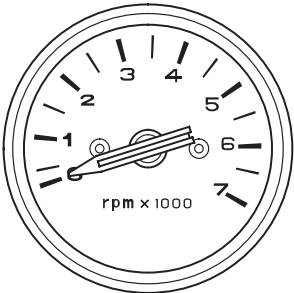

TACHOMETER
(optional equipment)
(R type)

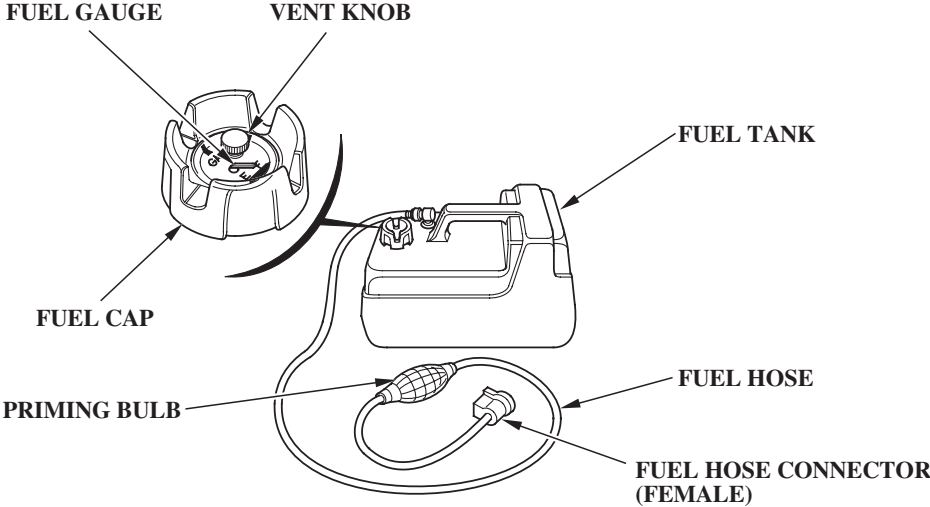

CONTROLS

H Type (tiller handle)

Engine Stop Switch and Switch Clip

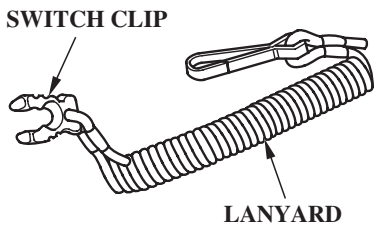
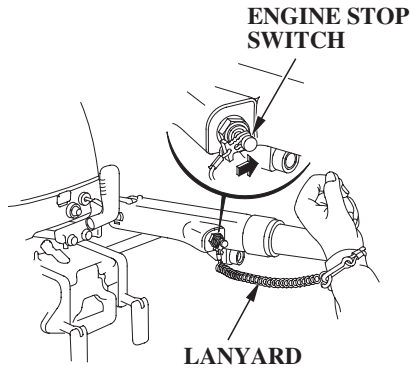

The engine stop switch has controls for normal engine stopping and emergency engine stopping.

The switch clip must be inserted in the engine stop switch in order for the engine to start and run. The lanyard should be attached to the operator's PFD (Personal Flotation Device) or worn around the wrist as shown.

When used as described, the engine stop switch and lanyard system stops the engine if the operator falls away from the controls.

A spare switch clip is supplied with the tool kit.

Choke Knob (H type manual choke)

CHOKE KNOB

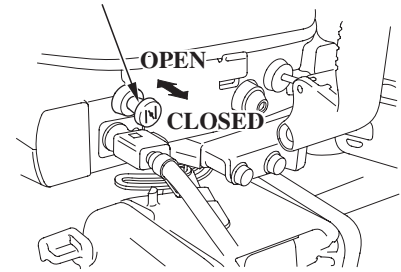

The choke knob opens and closes the choke valves in the carburetors.

The CLOSED position enriches the fuel mixture for starting a cold engine.

The OPEN position provides the correct fuel mixture for operation after starting, and for restarting a warm engine.

CONTROLS AND FEATURES

Throttle Grip

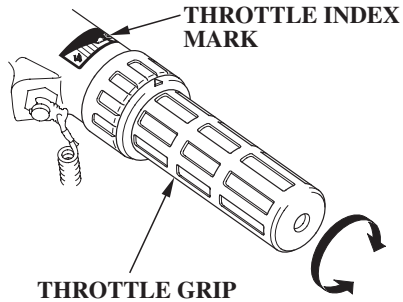

The throttle grip controls engine speed.

An index mark on the tiller arm shows throttle position and is helpful for setting the throttle correctly when starting (p. 39).

Throttle Friction Adjuster

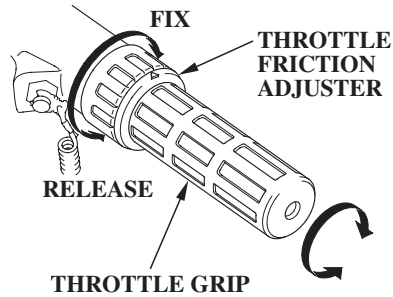

The throttle friction adjuster adjusts resistance to throttle grip rotation.

Turn the adjuster clockwise to increase friction for holding a throttle setting while cruising.

Turn the adjuster counterclockwise to decrease friction for easy throttle grip rotation.

Gearshift Lever

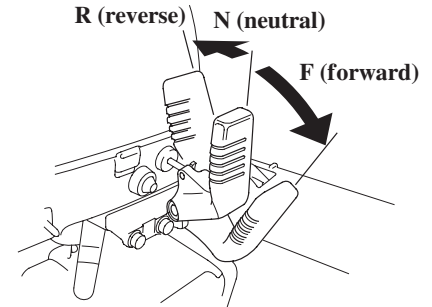

The gearshift lever is used to select F (forward), N (neutral), or R (reverse) gears.

The engine can be started with the gearshift lever in the N (neutral) position only.

If the gearshift lever is in the F (forward) or R (reverse) position, the recoil starter will not operate, and the electric starter button (applicable models) will not operate the starter motor.

Recoil Starter Grip

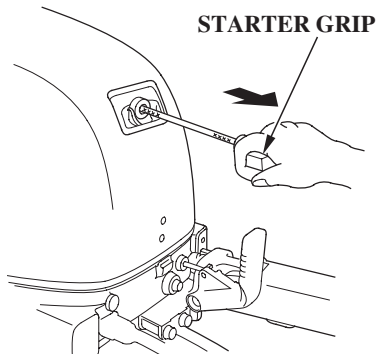

Pull the starter grip to operate the recoil starter for starting the engine manually.

The engine will not start unless the gearshift lever (p. 16) is in the N (neutral) position, and the clip is in the engine stop switch or the emergency stop switch.

Electric Starter Button (models equipped with electric starter)

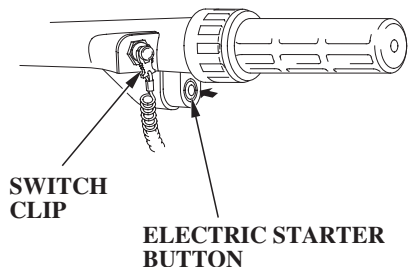

Press the starter button to operate the electric starter for starting the engine.

The electric starter button can be used to start the engine only when the gearshift lever (p. 16) is in the N (neutral) position, and the clip is in the engine stop switch.

Steering Friction Lever

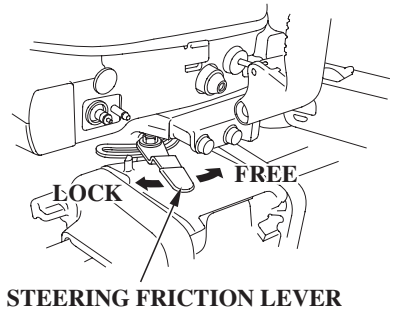

The steering friction lever adjusts steering resistance.

Less friction allows the outboard motor to turn more easily. More friction helps to hold steady course while cruising or to prevent the outboard motor from swinging while trailering the boat.

CONTROLS AND FEATURES

Power Tilt Switch (T type)

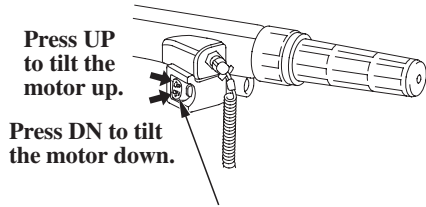

POWER TILT SWITCH

The power tilt switch is a rocker switch with UP and DN (down) positions for changing the angle of the outboard motor.

You can use the power tilt switch anytime.

Trim the outboard motor to obtain the best performance and stability (p. 52).

Tilt the outboard motor for shallow water operation, beaching, launching, or mooring.

Tilt Lever (G type) (gas-assisted tilt type)

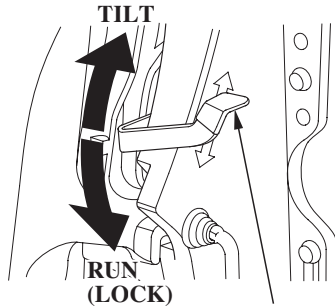

TILT LEVER

Moving the tilt lever to the TILT position allows the outboard motor to be tilted and moving the tilt lever to the RUN (LOCK) position locks the outboard motor in the desired position. Use the tilt lever to temporarily tilt the outboard motor when the boat is operating in shallow water, or mooring in shallow water. The tilt lever must be in the RUN (LOCK) position before operating the outboard motor or the motor could tilt up when operating in reverse.

R Type (remote control)

For panel-mount or top-mount remote control information, refer to the instructions provided with the remote control equipment.

Ignition Switch (side-mount type)

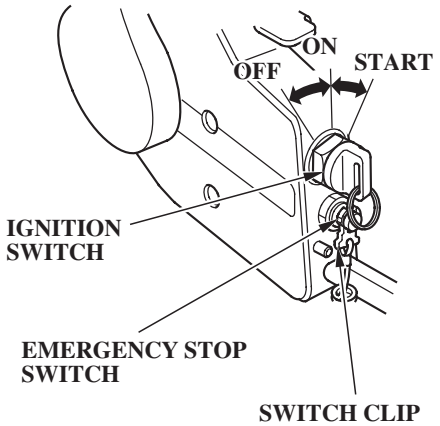

The ignition switch controls the ignition system and starter motor.

Turning the ignition switch key to the START position operates the starter motor. The key automatically returns to the ON position when released from the START position.

The ignition switch can be used to operate the starter motor only when the gearshift lever (p. 16) is in the N (neutral) position, and the switch clip is in the emergency stop switch.

Turning the ignition switch to the OFF position stops the engine.

Switch Clip and Emergency Stop Switch (side-mount type)

EMERGENCY STOP SWITCH

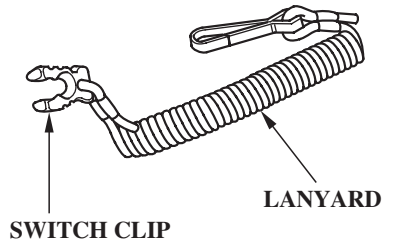
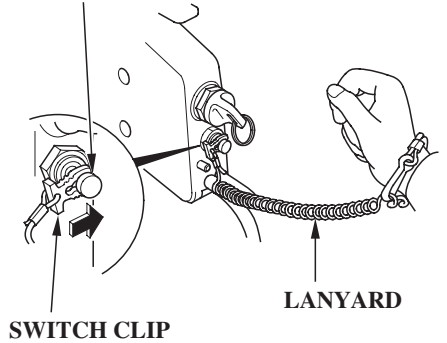

CONTROLS AND FEATURES

The switch clip must be inserted in the emergency stop switch in order for the engine to start and run. The lanyard must be attached to the operator's PFD (Personal Flotation Device) or worn around the wrist as shown.

When used as described, the emergency stop switch and lanyard system stops the engine if the operator falls away from the controls.

A spare switch clip is stored in a slot in the control housing.

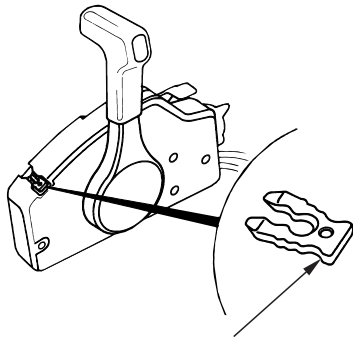

SPARE SWITCH CLIP

Fast Idle Lever

(side-mount type)

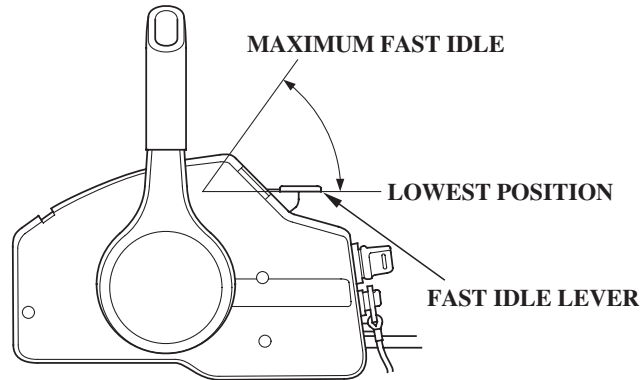

The fast idle lever is used to set idle speed during warm-up.

The lever will not move unless the gearshift/throttle control lever is in the N (neutral) position. Conversely, the gearshift/throttle control lever will not move unless the fast idle lever is in the lowest position.

Leave the fast idle lever in the lowest position to provide a rich fuel mixture for starting a cold engine.

Lift the fast idle lever to warm up a cold engine after starting and to start a warm engine.

Gearshift/Throttle Control Lever (side-mount type)

GEARSHIFT/THROTTLE CONTROL LEVER

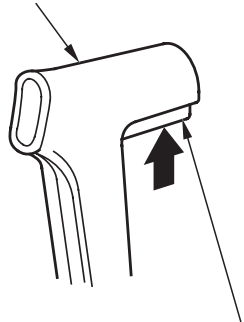

NEUTRAL RELEASE LEVER

The control lever automatically locks itself in the N (neutral) position. To move the lever out of the N (neutral) position, you must squeeze the neutral release lever on the underside of the lever handle.

GEARSHIFT/THROTTLE CONTROL LEVER

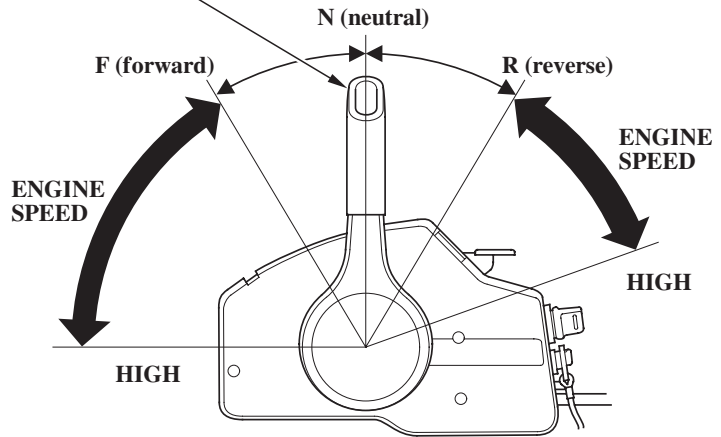

The gearshift/throttle control lever controls engine speed and selects F (forward), N (neutral), or R (reverse) gears.

Moving the control lever 30° from N (neutral) selects the gear, and further movement increases engine speed.

A friction adjuster near the base of the control lever adjusts the operating resistance of the control lever (p. 49).

Less friction allows easier control lever movement. More friction helps to hold a steady throttle setting while cruising.

CONTROLS AND FEATURES

Power Tilt Switch (T type) (side-mount type)

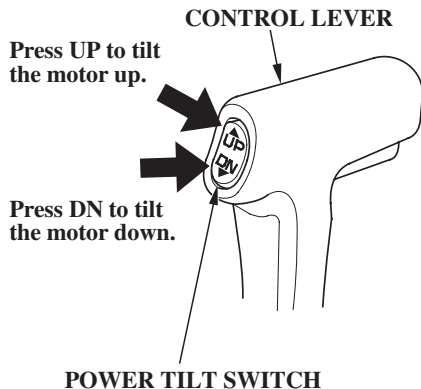

The power tilt switch is located on the control lever. It is a rocker switch with UP and DN (down) positions for changing the angle of the outboard motor.

You can use the power tilt switch anytime the ignition switch is ON, whether the boat is underway or stopped.

Trim the outboard motor to obtain the best performance and stability (p. 51).

Tilt the outboard motor for shallow water operation, beaching, launching, or mooring.

Manual Relief Valve (T type)

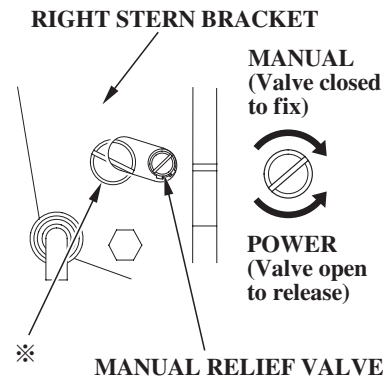

※ : Do not turn this screw. If this screw is turned hydraulic oil will bleed out of the power tilt system. Should this happen it will be necessary to consult your authorized Honda Marine dealer and have the system refilled.

The outboard motor can be tilted manually after opening the manual relief valve. This allows the outboard motor to be tilted when no battery is connected.

Tilt Lock Lever (G and T types)



The tilt lock lever is used to support the outboard motor in the fully-raised position.

When the boat is to be moored for a long time, tilt the outboard motor as far as it will go. Then move the tilt lock lever to the LOCK position, and gently lower the outboard motor until the lever contacts the stern bracket.

Common Controls

Engine Cover Latch

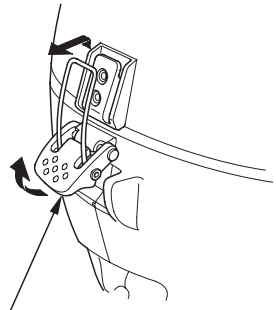

ENGINE COVER LATCH

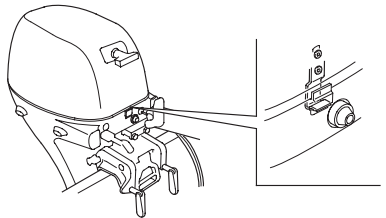

The engine cover latch fastens the engine cover to the outboard motor.

Transom Angle Adjusting Rod

The transom angle adjusting rod limits the tilt angle of the outboard motor when fully lowered.

(except G and T types)

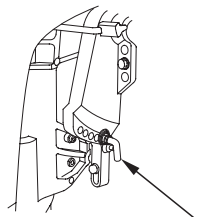

ADJUSTING ROD

(G and T types)

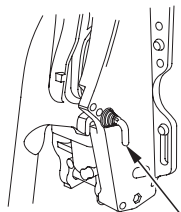

ADJUSTING ROD

Proper adjustment prevents the outboard motor from being trimmed in too far (p. 51).

CONTROLS AND FEATURES

Tilt Lever (except G and T types)

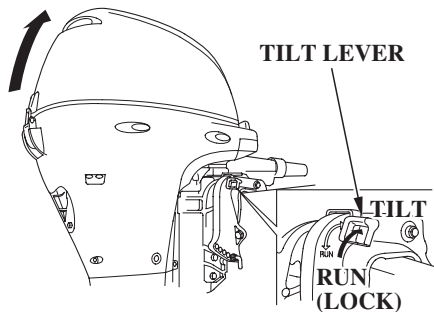

The tilt lever enables the outboard motor to be raised for shallow water operation, beaching, launching, or mooring.

To tilt, move the lever to the TILT position, then raise the outboard motor until the tilt mechanism engages at 30°, 45°, 71° or 72° (p. 54).

71° : Tiller handle S types.

72° : Tiller handle L, X types and Remote control types.

INSTRUMENTS

Fuel Gauge

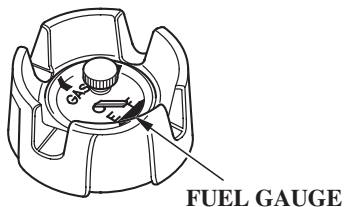

A fuel gauge is built into the cap of the portable fuel tank.

Tachometer (optional equipment) (R Type)

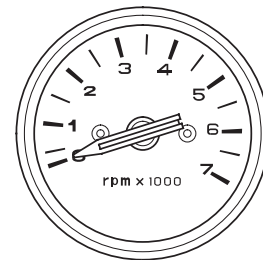

TACHOMETER

The tachometer shows engine speed in revolutions per minute.

Refer to the tachometer when using the throttle and power tilt controls to achieve the best performance from the boat.

INDICATORS

Oil Pressure Indicator (R type)

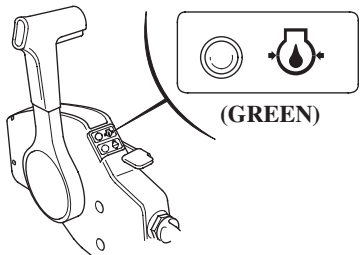

When the green light is lit, oil pressure is OK.

If oil pressure becomes low, the green light will go off, and the engine protection system will limit engine speed.

Remote controls are also equipped with a buzzer that sounds when the green light goes off. The buzzing sound stops below an engine speed of 1,400 rpm.

(H type)

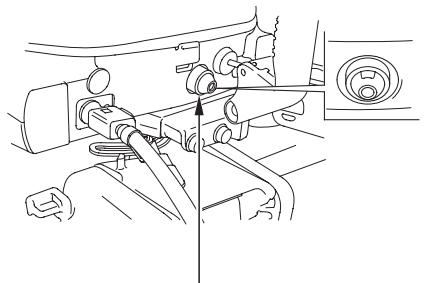

OIL PRESSURE INDICATOR LIGHT

Low oil pressure indicates that the engine oil level is low, or that there is a problem with the engine lubrication system.

Overheating Indicator (R type)

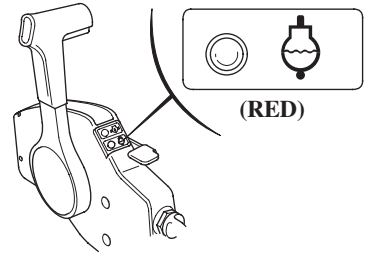

If the engine overheats, the red light will come on, and the engine protection system will limit engine speed.

Remote controls are also equipped with a buzzer that sounds when the red light comes on.

Engine overheating may be the result of clogged water intakes.

CONTROLS AND FEATURES

Cooling System Indicator

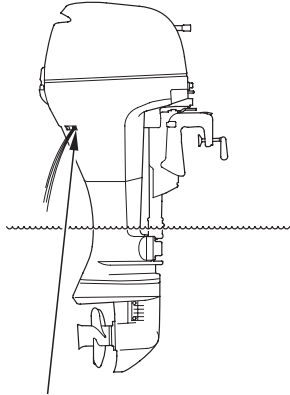

COOLING SYSTEM INDICATOR

Water should flow from the cooling system indicator while the engine is running. This shows that water is circulating through the cooling system.

If water stops flowing while the engine is running, that indicates a cooling system problem, such as clogged water intakes, which will cause engine overheating.

OTHER FEATURES

Overrev Limiter

The engine is equipped with an overrev limiter to prevent the possibility of mechanical damage from excessive engine speed.

The overrev limiter may be activated during operation, limiting engine speed, if the outboard motor is tilted excessively, or when propeller ventilation occurs during a sharp turn.

If the overrev limiter is activated, check the trim angle of the outboard motor.

Automatic Choke (models equipped with electric starter)

The engine is equipped with an automatic choke so that the choke system operation is not needed when starting the engine.

Anodes

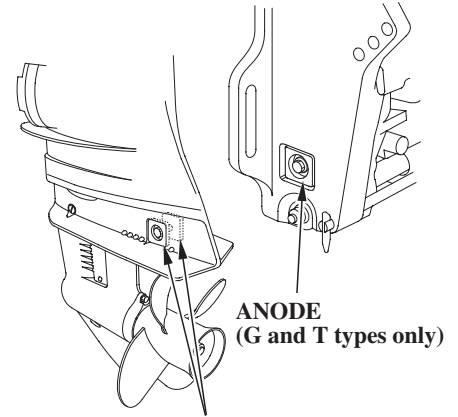

ANODES (each side)

The anodes are made of a sacrificial material that helps to protect the outboard motor from corrosion.

There are two anodes on the gear case, one on the stern bracket.

Portable Fuel Tank

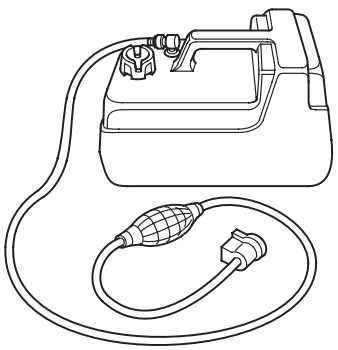

The portable fuel tank has a capacity of 3.2 US gal (12 ℓ) and has a fuel gauge built into the cap.

Fuel Cap Vent Knob

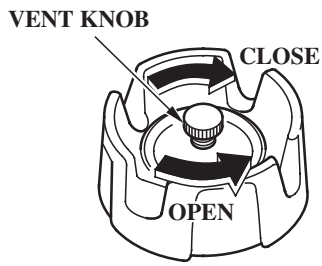

The cap is provided with a vent knob to seal the portable fuel tank for carrying it to and from the boat. Open the vent knob 2 or 3 turns before starting the engine (p. 37).

Fuel Priming Bulb

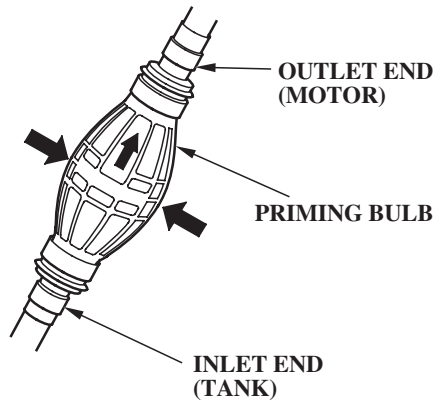

A priming bulb is built into the fuel hose that connects the fuel tank to the outboard motor.

Before starting the engine, squeeze the priming bulb until it feels firm. This will ensure that fuel is supplied to the engine (p. 38).

INSTALLATION

Correct and secure installation is essential for safe boating and good performance. Follow the installation instructions provided in this manual.

POWER REQUIREMENTS

Before installation, check to be sure that the outboard motor does not exceed the recommended maximum horsepower for the boat on which it is to be installed. Refer to the boat's certification plate for recommended maximum horsepower. If the certification plate information is not available, contact the boat dealer or manufacturer.

For most applications, the outboard motor should have a horsepower rating which provides 80% of the maximum recommended horsepower for the boat.

BOAT TRANSOM REQUIREMENTS

Honda BF15D/BFP15D/BF20D and BFP20D outboard motors can be installed on a boat transom having a thickness range of 1.3 – 2.2 inches (35 – 57 mm).

INSTALLATION POSITION

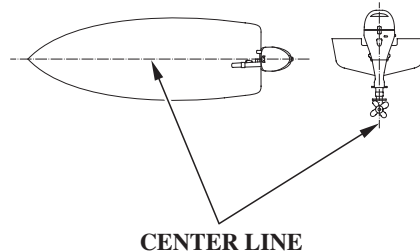

Install the outboard motor on the center of the boat transom.

The antiventilation plate of the outboard motor should be 0 – 2.0 inches below the bottom of the boat.

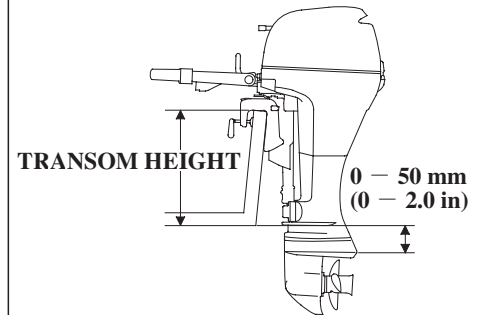

Type:	Transom Height
S:	17.0 in (433 mm)
L:	22.2 in (563 mm)
X:	27.7 in (703 mm)

If the outboard motor is installed too low, the boat will squat and be hard to plane, it will tend to porpoise, and high-speed stability will be reduced.

If the outboard motor is installed too high, that will cause ventilation.

Optimum installation height varies with boat type and bottom shape. Contact the boat manufacturer for any special recommendations that are unique to a specific model of boat.

If the transom needs to be modified to accommodate the outboard motor, contact the boat manufacturer and follow their recommendations for corrective action.

ATTACHMENT

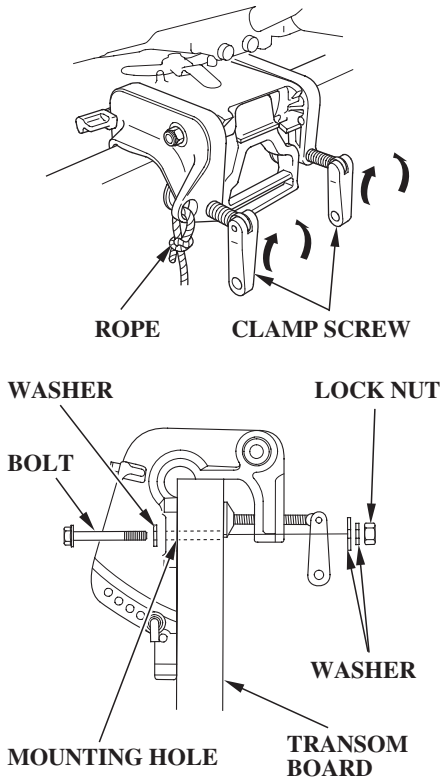

Attach the stern bracket to the boat transom by tightening the clamp screws.

Attach a rope from the boat to the hole in the stern bracket. This will help to prevent accidental loss of the outboard motor.

You may further secure the outboard motor by bolting the stern bracket to the boat transom. Use the optional mounting bolt and nut kit or other good quality stainless steel bolts, nuts, and washers. Apply silicone sealant to the bolt holes.

INSTALLATION

TRANSOM ANGLE ADJUSTMENT

Use the transom angle adjustment rod (p. 36) to adjust the angle of the outboard motor so the propeller is perpendicular to the surface of the water.

BATTERY CONNECTIONS

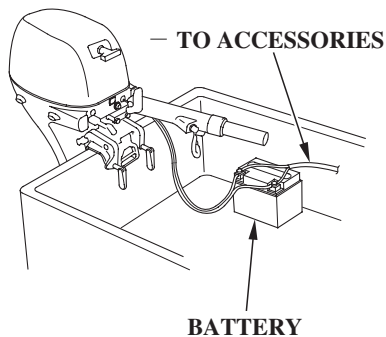

Honda BF15D/BFP15D/BF20D and BFP20D outboard motors produce a 12-volt, 12-ampere battery-charging current and are equipped for connection to a 12-volt battery. The battery-charging circuit is protected by a 20-ampere fuse located in the engine compartment.

The outboard motor's 12-volt output is intended for battery charging only. Lights and electrical accessories for the boat should be connected to the battery.

The battery should be kept in a corrosion-resistant battery box that is securely mounted in a location away from the fuel tank and protected from water and direct sunlight.

Types With Electric Starter

These types are equipped with battery cables. The positive (+) cable has a red band at the battery connector. The negative (-) cable has a black band at the battery connector.

For electric starter operation, use a 12-volt battery with an ampere-hour rating of at least 35 Ah (27 CCA).

Types With Manual Start

These types are equipped with a 12-volt DC battery-charging receptacle which can be wired to a 12-volt battery to power lights and electrical accessories for the boat.

Plug and Receptacle (models without electric starter)

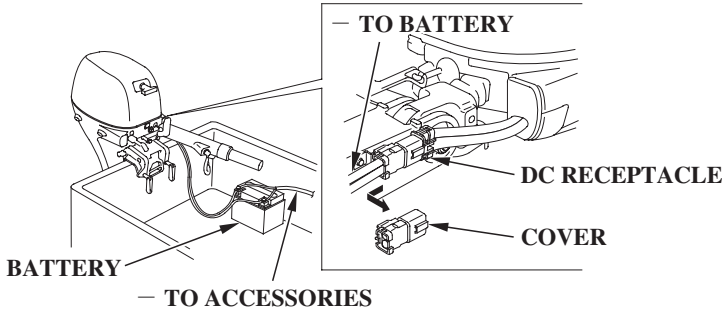

To prepare the outboard motor for connection to a battery, pull the cover out of the DC receptacle, connect your battery charging wires to the receptacle. Attach the connected DC receptacle on the holder on the tiller arm.

The receptacle is provided with a cover, which should be attached when the plug is removed, in order to keep the receptacle clean and dry.

Battery

For complete information, refer to the battery manufacturer's instructions.

Minimum Requirements

12V-35Ah (27 CCA)

Battery Terminals

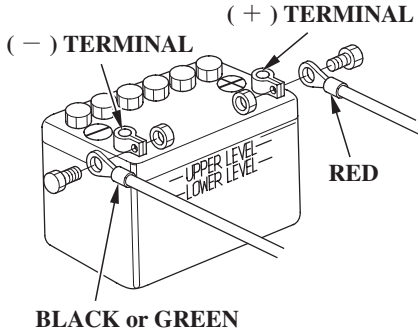

Connect the positive (+) battery cable to the positive (+) battery terminal, then connect the negative (-) battery cable to the negative (-) battery terminal.

The negative (-) battery cable should always be removed from the battery when connecting or disconnecting the positive (+) battery cable, so tools cannot cause a short circuit if they touch a grounded part while being used on the positive (+) battery terminal fitting.

INSTALLATION

NOTICE

Be careful to avoid connecting the battery in reverse polarity, as that will damage the battery-charging system in the outboard motor.

ARE YOU READY TO GET UNDER WAY ?

Your safety is your responsibility. A little time spent in preparation will significantly reduce your risk of injury.

Knowledge

Read and understand this manual. Know what the controls do and how to operate them.

Familiarize yourself with the outboard motor and its operation before you get under way. Know what to do in case of emergencies.

Familiarize yourself with all laws and regulations relating to boating and the use of outboard motors.

Safety

Always wear a PFD (Personal Flotation Device) while on the boat.

Attach the emergency stop switch lanyard securely to your PFD or to your wrist.

IS YOUR OUTBOARD MOTOR READY TO GO ?

For your safety, and to maximize the service life of your equipment, it is very important to take a few moments before you operate the outboard motor to check its condition. Be sure to take care of any problem you find, or have your authorized Honda Marine dealer correct it, before you operate the outboard motor.

BEFORE OPERATION

WARNING

Improperly maintaining this outboard motor, or failing to correct a problem before operation, could cause a malfunction in which you could be seriously injured.

Always perform a preoperation inspection before each operation, and correct any problem.

Before beginning your preoperation checks, be sure the ignition switch is in the OFF position.

BEFORE OPERATION

Safety Inspection

- Look around the outboard motor for signs of oil or gasoline leaks.
- If you are using the portable fuel tank, make sure it is in good condition and properly secured in the boat (p. 37).
- Check that the fuel hose is undamaged and properly connected (p. 37).
- Wipe up any spills before starting the engine.
- Check the stern bracket to be sure the outboard motor is securely installed.
- Check that all controls are operating properly.
- Replace any damaged parts.
- Check that all fasteners are in place and securely tightened.

Maintenance Inspection

- Check the engine oil level (p. 65). Running the engine with a low oil level can cause engine damage.
- Check to be sure the propeller is undamaged, and the castle nut is secured with the cotter pin (p. 79).
- Check that the anodes are securely attached to the gear case (p. 78) and are not excessively worn. The anodes help to protect the outboard motor from corrosion.
- Make sure the tool kit and emergency starter rope are onboard (p. 61). Replace any missing items.
- Check the fuel level in the fuel tank (p. 74).

SAFE OPERATING PRECAUTIONS

To safely realize the full potential of this outboard motor, you need a complete understanding of its operation and a certain amount of practice with its controls.

Before operating the outboard motor for the first time, please review the *IMPORTANT SAFETY INFORMATION* on page 7 and the chapter titled *BEFORE OPERATION*.

For your safety, avoid starting or operating the engine in an enclosed area. Your engine's exhaust contains poisonous carbon monoxide gas which can collect rapidly in an enclosed area and cause illness or death.

BREAK-IN PROCEDURE

Break-in period: 10 hours

Proper break-in operation allows the moving parts to wear in smoothly for best performance and long service life.

First 15 minutes:

Run the engine at trolling speed. Use the minimum throttle opening necessary to operate the boat at a safe trolling speed.

Next 45 minutes:

Run the engine up to a maximum of 2,000 to 3,000 rpm, which is about 10% to 30% of maximum throttle opening.

Next 60 minutes:

Run the engine up to a maximum of 4,000 to 5,000 rpm, which is about 50% to 80% of maximum throttle opening.

Short full-throttle bursts are OK, but do not operate the engine continuously at full throttle.

For boats that plane easily, bring the boat up on plane, and then reduce the throttle opening to the recommended rpm range.

Next 8 hours:

Do not run the engine at full throttle for more than 5 minutes at a time.

OPERATION

TRANSOM ANGLE ADJUSTMENT

(except G and T types)

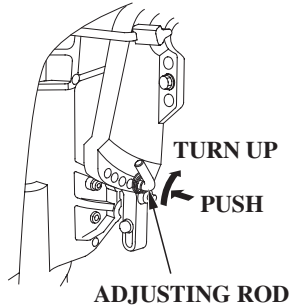

(G and T types)

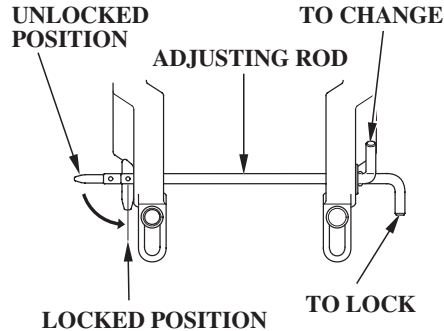
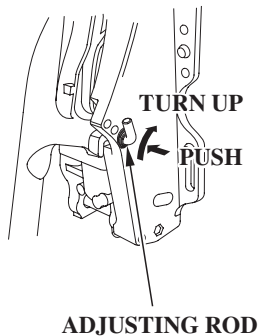

The transom angle adjusting rod limits the tilt angle of the outboard motor when fully lowered.

Proper adjustment prevents the outboard motor from being trimmed too low (p. 51).

To adjust, first tilt the outboard motor so it is not resting on the rod.

Push the rod in and turn the end of the rod up, so the latch will fall into line with the rod.

Remove the rod and reinsert it in the desired position.

Push the rod in and turn the end of the rod down, so the latch will fall to the locked position. Then release the rod.

NOTICE

Do not allow water to enter the idle exhaust port or the engine can be damaged.

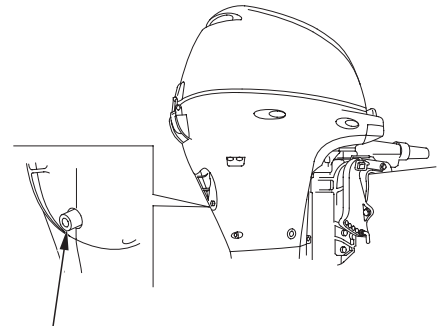

PORTABLE FUEL TANK

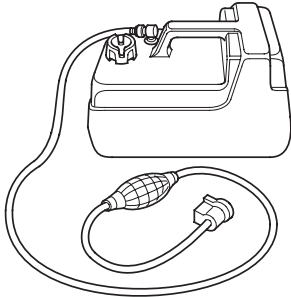

Place the portable fuel tank in a well-ventilated location, away from direct sunlight, to reduce the possibility of a gasoline vapor explosion.

To ensure that the outboard motor will be able to draw fuel from the tank, place the tank within 6 feet of the outboard motor and not more than 3 feet below the fuel connector on the outboard motor.

Secure the portable fuel tank in the boat, so it won't move around and become damaged.

Before use, open the fuel tank vent by turning the vent knob at least 2 or 3 turns counterclockwise.

⚠ WARNING

Gasoline is highly flammable and explosive.

You can be burned or seriously injured when handling fuel.

- Stop the engine and keep heat, sparks, and flame away.
- Handle fuel only outdoors.
- Wipe up spills immediately.

FUEL HOSE CONNECTIONS

FUEL HOSE CONNECTOR

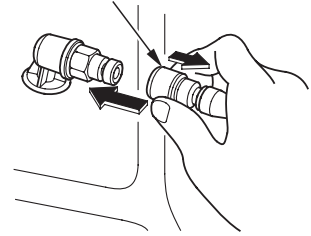

(FUEL TANK SIDE)

FUEL HOSE CONNECTOR

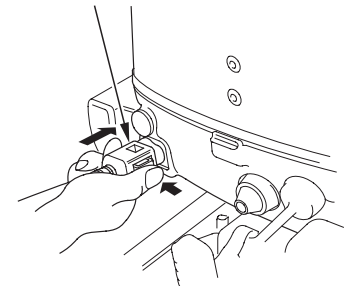

(OUTBOARD MOTOR SIDE)

Connect the fuel hose to the tank and the outboard motor, as shown. Be sure both connectors snap securely into place.

OPERATION

FUEL PRIMING

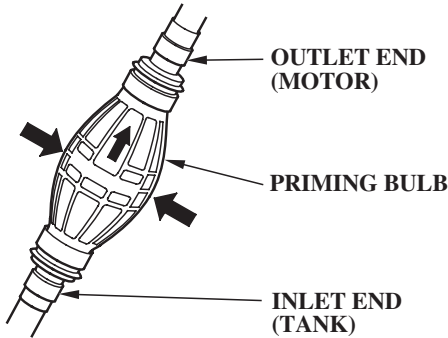

Hold the priming bulb with the outlet end higher than the inlet end. Squeeze the priming bulb several times, until it feels firm, indicating that fuel has reached the carburetor.

Check to be sure there are no fuel leaks before starting the engine.

Do not squeeze the priming bulb when the engine is running because that could flood the carburetors.

STARTING THE ENGINE

H Type (tiller handle)

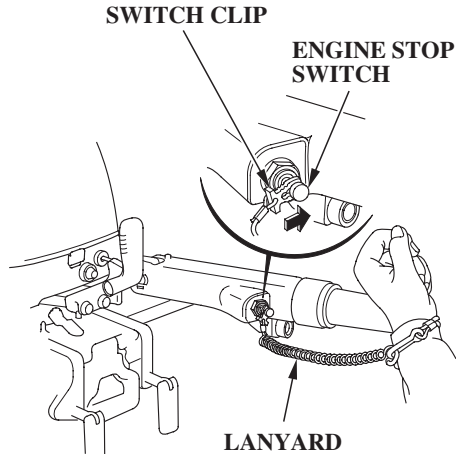

1. Put the emergency stop switch clip in the engine stop switch, and attach the lanyard to your PFD (Personal Flotation Device) or to your wrist, as shown.

The engine will not start or run, unless the switch clip is in the engine stop switch.

The emergency stop switch clip and lanyard system is a safety device that will stop the engine if you fall away from the controls while operating the boat.

Always attach the lanyard to your PFD, or to your wrist, before starting the engine.

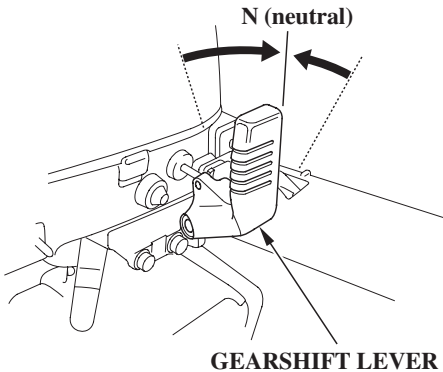

2. Check the position of the gearshift lever. It must be in the N (neutral) position for starting.

The engine will not start if the gearshift lever is in the F (forward) or R (reverse) position.

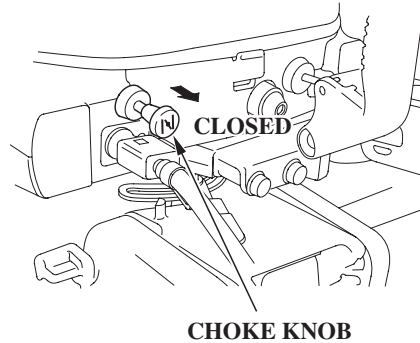

(manual choke type)

3. To start a cold engine, pull the choke knob to the CLOSED position. To restart a warm engine, leave the choke knob in the OPEN position.

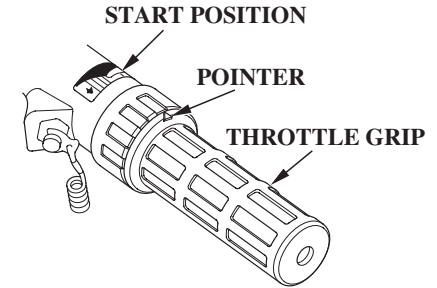

4. Do not turn the throttle grip before starting and align the START position with the pointer for starting the engine.

OPERATION

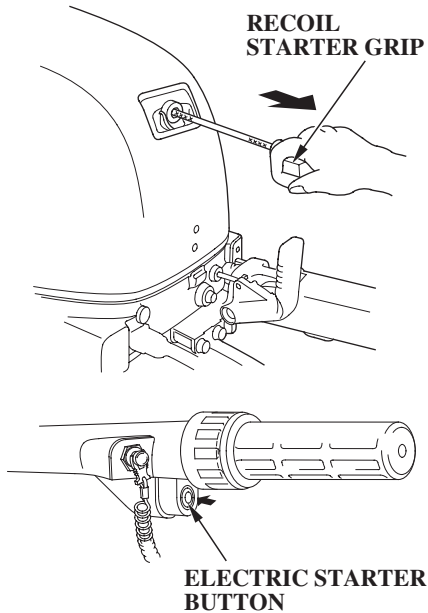

5. Recoil starter

Pull the recoil starter grip slowly until you feel resistance, then pull briskly.

Return the starter grip gently.

Electric starter
(electric starter model)

Press the electric starter button and hold it there until the engine starts.

When the engine starts, release the button.

If the engine fails to start within 5 seconds, release the button, and wait at least 10 seconds before operating the starter again.

NOTICE

- *Using the electric starter for more than 5 seconds at a time will overheat the starter motor and can damage it.*
- *Pushing the electric starter button while the engine is running can damage the starter motor and flywheel.*

6. (Manual Start only)

If the choke knob was pulled to the CLOSED position to start the engine, gradually push it to the OPEN position as the engine warms up.

Also, as the engine warms up, the throttle grip can be turned to the SLOW position without stalling.

7. Before getting under way, allow the engine to warm up sufficiently to ensure good performance.

During the warm-up period, check the oil pressure indicator (p. 25) and cooling system indicator (p. 26).

If the indicators show any abnormal condition, immediately stop the engine and determine the cause of the problem. Refer to *TAKING CARE OF UNEXPECTED PROBLEMS*, p. 87.

**R Type
(remote control)**

For panel-mount or top-mount remote control information, refer to the instructions provided with the remote control equipment.

Side-Mount Type

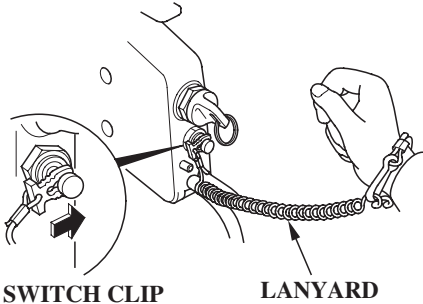

1. Put the emergency stop switch clip in the emergency stop switch, and attach the lanyard to your PFD (Personal Flotation Device) or to your wrist, as shown.

The engine will not start or run, unless the switch clip is in the emergency stop switch.

The emergency stop switch clip and lanyard system is a safety device that will stop the engine if you fall away from the controls while operating the boat.

Always attach the lanyard to your PFD, or to your wrist, before starting the engine.

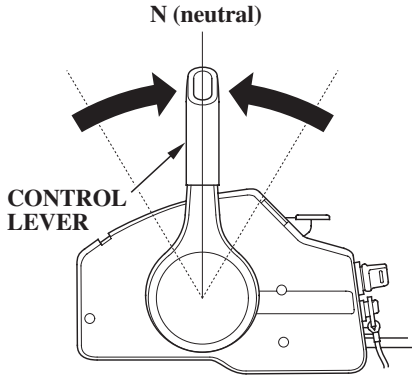

2. Set the control lever in the N (neutral) position.

The engine will not start if the F (forward) or R (reverse) gears are engaged.

OPERATION

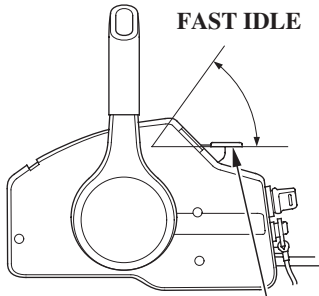

FAST IDLE LEVER

3. To start a cold engine, leave the fast idle lever in the OFF (fully lowered) position.

To restart a warm engine, raise the fast idle lever.

Fast idle lever cannot be raised unless the control lever is in the N (neutral) position.

The control lever cannot be moved away from the N (neutral) position unless the fast idle lever is lowered.

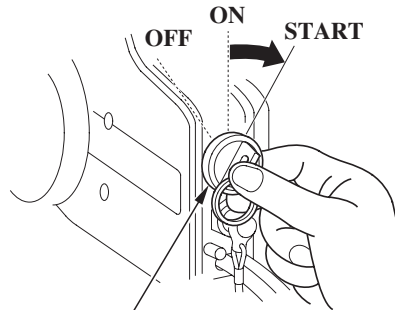

IGNITION SWITCH KEY

4. Turn the ignition switch key to the START position and hold it there until the engine starts.

When the engine starts, release the key, allowing it to return to the ON position.

If the engine fails to start within 5 seconds, release the key and wait at least 10 seconds before operating the starter again.

NOTICE

- *Using the electric starter for more than 5 seconds at a time will overheat the starter motor and can damage it.*
- *Turning the ignition switch key to the START position while the engine is running can damage the starter motor and flywheel.*

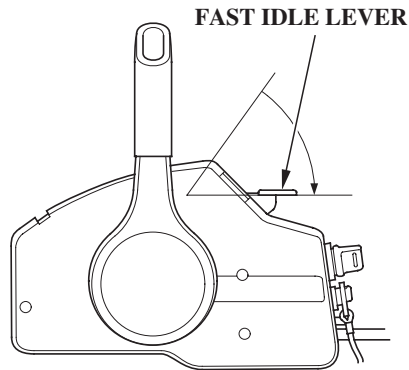

5. If the fast idle lever was used to start the engine, gradually lower the lever as the engine warms up.

When the fast idle lever is fully lowered, the control lever can be moved away from the N (neutral) position.

6. Before getting under way, allow the engine to warm up sufficiently to ensure good performance.

Above 41°F (5°C), warm up the engine for 2 or 3 minutes.

Below 41°F (5°C), warm up the engine for at least 10 minutes at 2,000 rpm.

During the warm-up period, check the oil pressure indicator (p. 25), overheating indicator (p. 25), and cooling system indicator (p. 26).

If the indicators show any abnormal condition, immediately stop the engine and determine the cause of the problem. Refer to *TAKING CARE OF UNEXPECTED PROBLEMS*, p. 87.

EMERGENCY STARTING

If the battery is discharged, or the starter motor and the recoil starter are inoperative, you can start the engine manually using the emergency starter rope supplied with the tool kit.

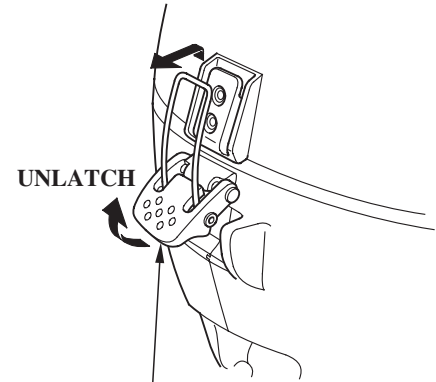

ENGINE COVER LATCH

1. Unlatch and remove the engine cover.

OPERATION

NEUTRAL START CABLE

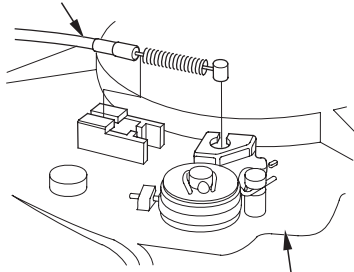

RECOIL STARTER ASSEMBLY

2. Move the shift lever to the F (forward) position. Loosen the neutral start cable lock nut and disconnect the neutral start cable. Unscrew the three flange bolts and remove the recoil starter assembly.

3. Set the controls the same as for normal starting (see pages 38 — 43). Use the choke and fast idle controls if needed.

Turn the ignition switch key to the ON position.

FLANGE BOLT RECOIL STARTER ASSEMBLY

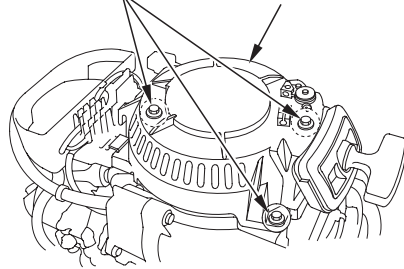

4. Set the knotted end of the emergency starter rope in the notch in the flywheel. Wind the rope clockwise around the flywheel, as shown.

FLYWHEEL (STARTER PULLEY) STARTER ROPE KNOT

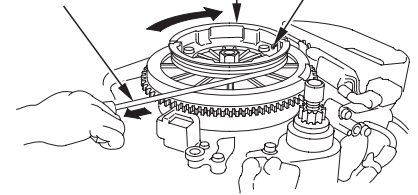

5. Pull the emergency starter rope slowly until resistance is felt, then pull briskly.

Keep away from moving parts while pulling the rope.

If necessary, rewind the rope and pull again. If the engine does not start after several attempts, refer to *TAKING CARE OF UNEXPECTED PROBLEMS*, p. 87 .

6. If the choke and fast idle control(s) was used to start the engine, return the control(s) to the normal operating position as the engine warms up.

During the warm-up period, check the oil pressure indicator (p. 25), overheating indicator (p. 25), and cooling system indicator (p. 26).

7. Leave the recoil starter assembly off, but install the engine cover (p. 23), and lock it in place by latching the engine cover latch.

WARNING

Exposed moving parts can cause injury.

- Do not operate the outboard motor without the engine cover.
- Use extreme care when installing the engine cover.

8. If it was necessary to remove the emergency stop switch lanyard from your wrist to perform the emergency starting procedure, be sure the lanyard is attached to your wrist before operating the outboard motor.

9. Have your closest authorized Honda marine dealer check your electrical system and correct the problem, so you can use the electric starter.

The recoil starter assembly (p. 44) should be reinstalled after the electric starter is working again. Install the recoil starter assembly with the engine stopped.

OPERATION

STOPPING THE ENGINE

Emergency Engine Stopping

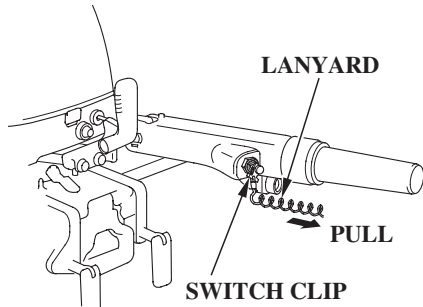

To stop the engine in an emergency, pull the switch clip out of the engine or emergency stop switch by pulling the lanyard.

We suggest that you stop the engine this way occasionally to verify that the engine emergency stop switch is operating properly.

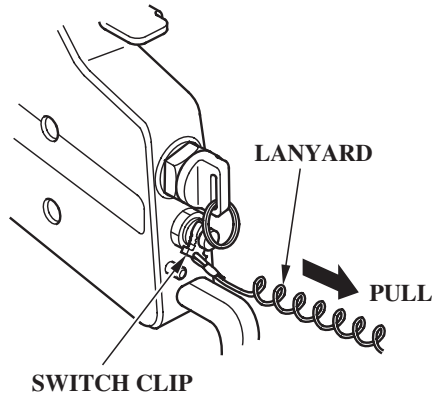

Normal Engine Stopping

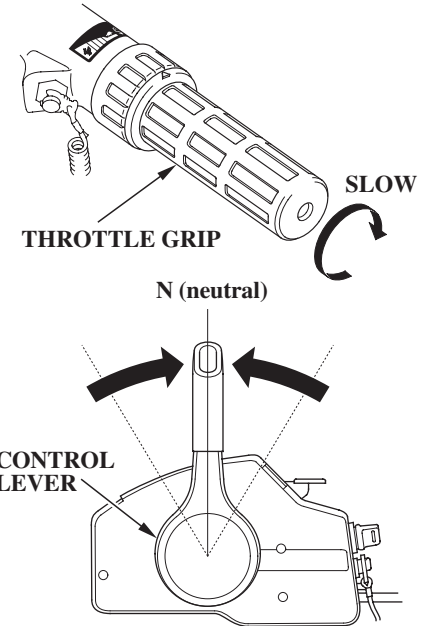

1. Move the throttle grip to the slowest speed and control gears to N (neutral) position.

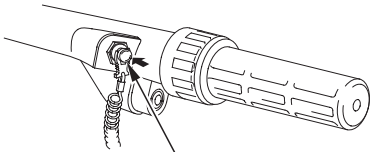

ENGINE STOP SWITCH

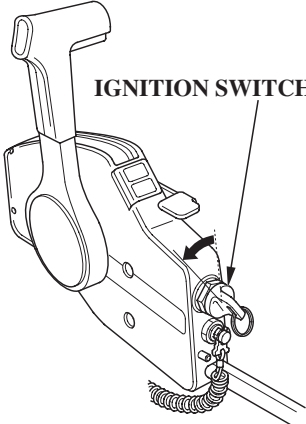

IGNITION SWITCH KEY

2. Turn the ignition switch key to the OFF position or press the engine stop switch until the engine stops.

3. When the boat is not in use, remove and store the ignition key and the emergency stop switch clip and lanyard.

OPERATION

GEARSHIFT AND THROTTLE OPERATION

H Type (tiller handle)

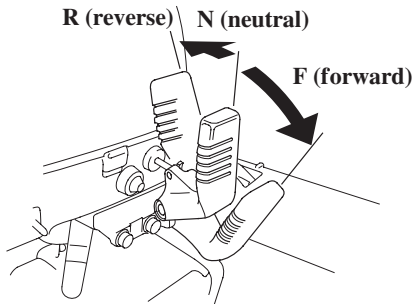
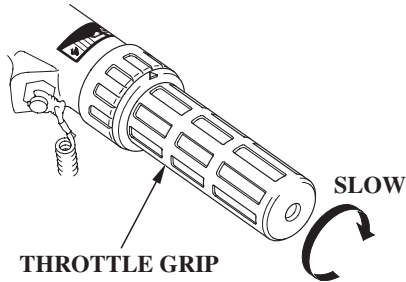

To shift gears, turn the throttle grip to the SLOW position, then move the gearshift lever to select F (forward), N (neutral) or R (reverse) gears.

The engine can be started with the gearshift lever in the N (neutral) position only.

The throttle grip can be turned to the FAST position only when the gearshift lever is in the F (forward) position.

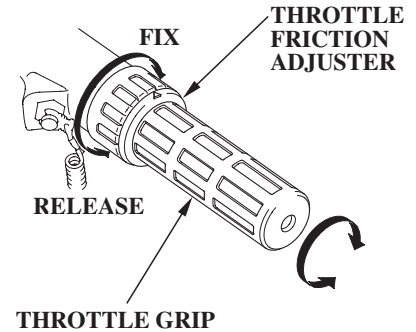

Use the throttle friction adjuster to help hold a constant throttle setting while cruising.

Turn the adjuster clockwise to increase throttle grip friction for holding a constant speed.

Turn the adjuster counterclockwise to decrease friction for easy grip rotation.

**R Type
(remote control)**

Side-Mount Type

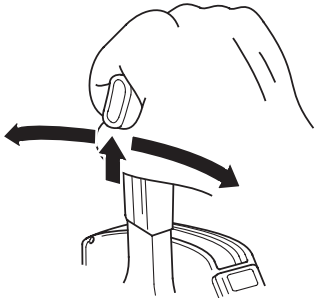
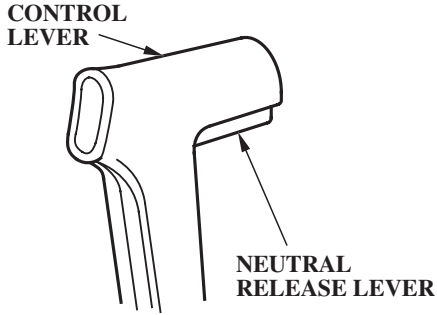

To shift gears, move the control lever to select F (forward), N (neutral) and R (reverse) gears.

The control lever cannot be moved from the N (neutral) position unless the neutral release lever is squeezed.

Moving the control lever beyond the gear selection range increases engine speed.

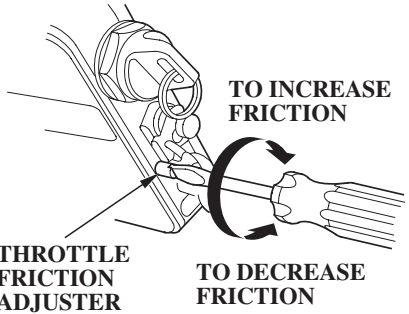

Adjust the throttle friction adjuster so the control lever will hold a constant throttle setting while cruising.

OPERATION

STEERING

H Type (tiller handle)

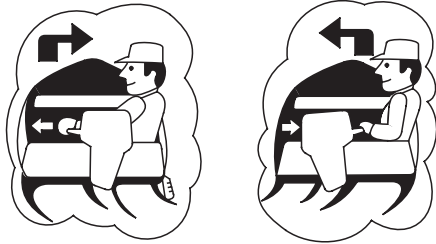

Steer by moving the tiller handle opposite the direction you want the boat to turn.

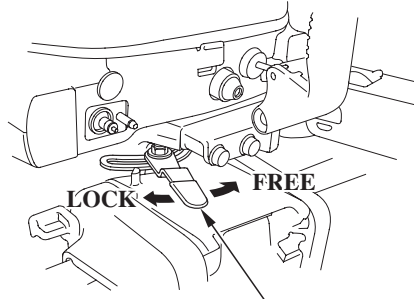

STEERING FRICTION LEVER

Use the steering friction lever to help hold a steady course while cruising.

Move the lever to the **LOCK** direction to increase steering friction for holding a steady course.

Move the lever to the **FREE** direction to decrease friction for easy turning.

R Type (remote control)

Steer the boat in the same manner as an automobile.

CRUISING

Engine Speed

For best fuel economy, limit the throttle opening to 80%. Use the throttle friction control (p. 45 or p. 49) to help you hold a steady speed.

For rough water conditions or large waves, slow down to prevent the propeller from rising out of the water.

The engine is equipped with an overrev limiter to prevent the possibility of mechanical damage from excessive engine speed.

If, for example, the outboard motor is tilted excessively, or propeller ventilation occurs during a sharp turn, the engine may overrev, activating the overrev limiter.

If engine speed becomes unstable at high speed due to activation of the overrev limiter, reduce speed and check the trim angle of the outboard motor.

Trim (except T type)

Install the outboard motor at the best trim angle for stable cruising and maximum power.

Trim angle too large: Incorrect causes boat to “squat”.

Trim angle too small: Incorrect causes boat to “plow”.

It is necessary to trim the angle of the outboard motor to compensate for changes in boat load, weight distribution, water conditions, or propeller selection.

Under normal conditions, the boat will perform best when the antiventilation plate is level with the water.

When cruising into a high wind, trim the outboard motor down slightly to level the boat and improve stability. With a tail wind, trim the outboard motor up slightly.

OPERATION

NOTICE

Excessive tilt angle during operation can cause propeller ventilation, overheating, and water pump damage.

Motor Angle (Crusing)

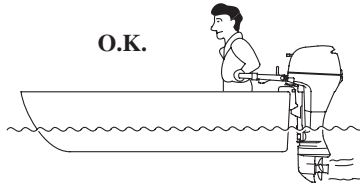

**CORRECT
GIVES MAXIMUM PERFORMANCE**

Trim (T type)

Use the power tilt switch to trim the outboard motor for the best performance and stability.

Press the UP or DN (down) side of the switch to adjust the angle of the outboard motor.

It is necessary to trim the angle of the outboard motor to compensate for changes in boat load, weight distribution, water conditions, or propeller selection.

Under normal conditions, the boat will perform best when the antiventilation plate is level with the water.

NOTICE

Excessive tilt angle during operation can cause propeller ventilation, overheating, and water pump damage.

Tiller Handle Type

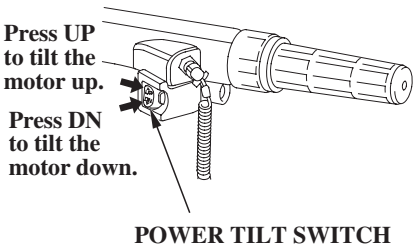

Remote Control Type

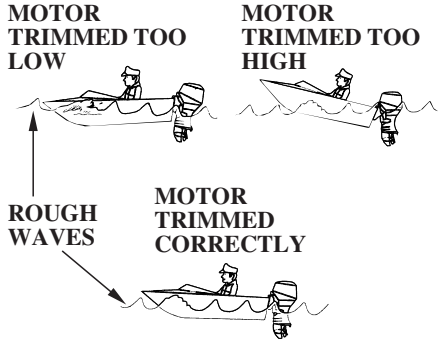
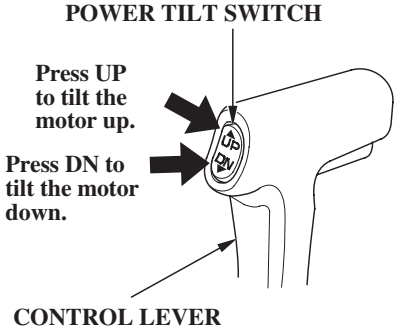

BOW TOO LOW DUE TO
1. LOAD IN THE FRONT
2. MOTOR TRIMMED TOO LOW

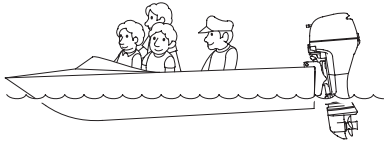

BOW TOO HIGH DUE TO
1. LOAD IN THE REAR
2. MOTOR TRIMMED TOO HIGH

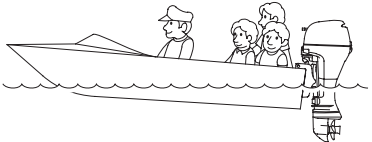

OPERATION

SHALLOW WATER OPERATION

Except G and T Types

When operating in shallow water, tilt the outboard motor, using the tilt lever, so the propeller and gear case won't hit the bottom.

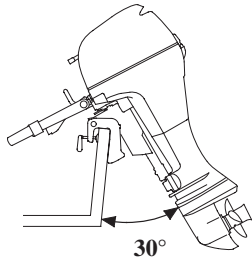
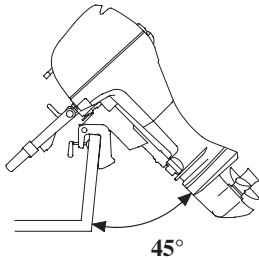

To tilt the outboard motor, move the tilt lever to the TILT position, then raise the outboard motor to the 30° or 45° position by pulling on the engine cover grip.

NOTICE

Do not use the tiller handle as a lever to raise the outboard motor. Applying excessive force to the tiller handle can damage it.

While the outboard motor is tilted, proceed at a low speed, and do not operate the outboard motor in reverse. The outboard motor will rise suddenly if operated in reverse.

Monitor water flow from the cooling system indicator (p. 26) to be sure the outboard motor is not tilted so high the water intake is out of the water.

NOTICE

An excessive tilt angle during operation can cause propeller ventilation, overheating, and water pump damage.

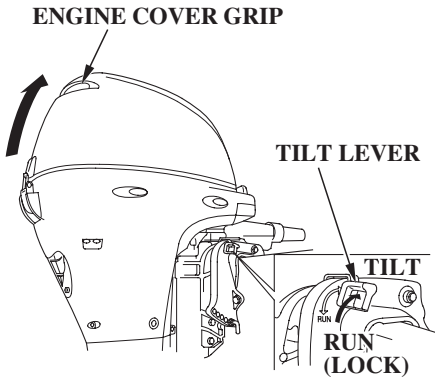

To return the outboard motor to the normal operating position, move the tilt lever to the RUN (LOCK) position, raise the outboard motor slightly to disengage the tilt mechanism, then slowly lower the outboard motor.

T Type

When operating in shallow water, use the power tilt switch (p. 52) to tilt the outboard motor, so the propeller and gear case won't hit the bottom.

Proceed at low speed, and monitor water flow from the cooling system indicator (p. 26) to be sure the outboard motor is not tilted so high that the water intakes are out of the water.

NOTICE

An excessive tilt angle during operation can cause propeller ventilation, overheating, and water pump damage.

G Type

When operating in shallow water, tilt the outboard motor, using the tilt lever, so the propeller and gear case won't hit the bottom.

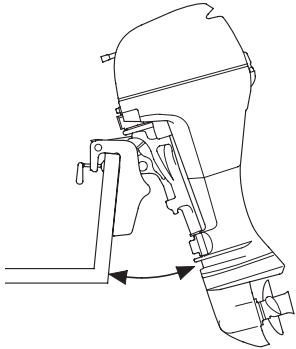

OPERATION

To tilt the outboard motor, move the tilt lever to the TILT position, then raise the outboard motor to the desired position by pulling on the engine cover grip.

NOTICE

Do not use the tiller handle as a lever to raise the outboard motor. Applying excessive force to the tiller handle can damage it.

While the outboard motor is tilted, proceed at a low speed, and do not operate the outboard motor in reverse. The outboard motor will rise suddenly if operated in reverse.

Monitor water flow from the cooling system indicator (p. 26) to be sure the outboard motor is not tilted so high the water intake is out of the water.

NOTICE

An excessive tilt angle during operation can cause propeller ventilation, overheating, and water pump damage.

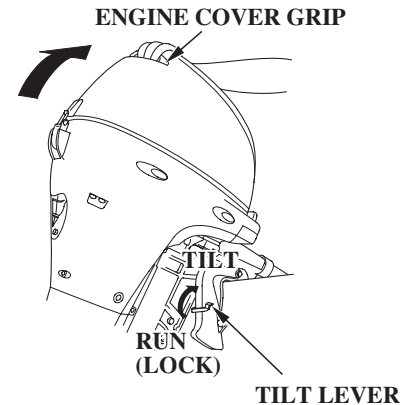

To return the outboard motor to the normal operating position, move the tilt lever to the RUN (LOCK) position, you may need to raise the outboard motor slightly to disengage the tilt mechanism, then slowly lower the outboard motor.

**MOORING, BEACHING,
LAUNCHING
Except G and T Types**

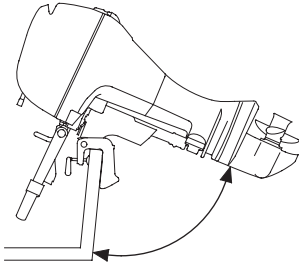

71° or 72° (when mooring)

To raise the outboard motor out of the water while the boat is moored, or for maximum clearance when beaching or launching, tilt the outboard motor to the 71° or 72° position.

Stop the engine before tilting the outboard motor. The 71° or 72° position is not an operating position.

Raise and lower the outboard motor as described on p. 54 .

G and T Types

To raise the outboard motor out of the water while the engine is stopped and the boat is moored, or for maximum clearance when beaching or launching, use the power tilt switch to tilt the outboard motor as far as it will go, move the tilt lock lever to the LOCK position, then gently lower the outboard motor until the lever contacts the stern bracket.

If more clearance is needed to swing the tilt lock lever into the LOCK position, rock the outboard motor back slightly by pulling on the engine cover grip.

To lower the outboard motor, tilt up, move the tilt lock lever to the FREE position, then lower the outboard motor to the desired position.



NOTICE

Do not attempt to use the power tilt switch to tilt the outboard motor down while the tilt lock lever is in the lock position. Damage to the power tilt system may occur.

OPERATION

T Type

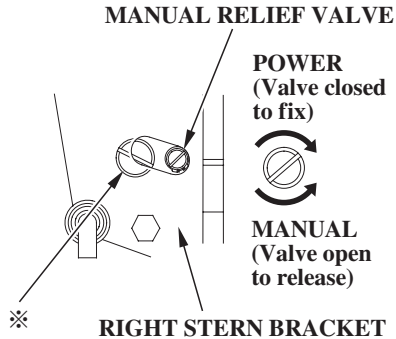

※ : Do not turn this screw. If this screw is turned hydraulic oil will bleed out of the power tilt system. Should this happen it will be necessary to contact your closest authorized Honda Marine dealer and have the system refilled.

The outboard motor can also be tilted manually after opening the manual relief valve. This feature enables the outboard motor to be tilted when no battery is connected.

For manual tilting, use a flat screwdriver to turn the valve counterclockwise 2 and a half turns. Close the valve firmly after positioning the engine.

Be sure the valve is closed before operating the outboard motor. If the valve is not closed, the outboard motor will tilt up when operated in reverse.

SERVICING YOUR OUTBOARD MOTOR

THE IMPORTANCE OF MAINTENANCE

Good maintenance is essential for safe, economical, and trouble-free operation. It will also help reduce air pollution.

WARNING

Improperly maintaining this outboard motor, or failure to correct a problem before operation, can cause a malfunction in which you could be seriously hurt or killed.

Always follow the inspection and maintenance recommendations and schedules in this owner's manual.

To help you properly care for your outboard motor, the following pages include a maintenance schedule, routine inspection procedures, and simple maintenance procedures using basic hand tools. Other service tasks that are more difficult, or require special tools, are best handled by professionals and are normally performed by a Honda technician or other qualified mechanic.

The maintenance schedule applies to normal operating conditions. If you operate your outboard motor under unusual conditions, consult an authorized Honda marine dealer for recommendations applicable to your individual needs and use.

Remember that your authorized Honda marine dealer knows your outboard motor best and is fully equipped to maintain and repair it.

To ensure the best quality and reliability, use only new, genuine Honda parts or their equivalents for repair and replacement.

Maintenance, replacement, or repair of the emission control devices and systems may be performed by any marine engine repair establishment or individual, using parts that are “certified” to EPA standards.

SERVICING YOUR OUTBOARD MOTOR

MAINTENANCE SAFETY

Some of the most important safety precautions follow. However, we cannot warn you of every conceivable hazard that can arise in performing maintenance. Only you can decide whether or not you should perform a given task.

WARNING

Failure to properly follow maintenance instructions and precautions can cause you to be seriously hurt or killed.

Always follow the procedures and precautions in the owner's manual.

Safety Precautions

- Make sure the engine is off before you begin any maintenance or repairs. This will eliminate several potential hazards:

- **Carbon monoxide poisoning from engine exhaust.**

Be sure there is adequate ventilation whenever you operate the engine.

- **Burns from hot parts.**

Let the engine and exhaust system cool before touching.

- **Injury from moving parts.**

Do not run the engine unless instructed to do so.

- Read the instructions before you begin, and make sure you have the tools and skills required.
- To reduce the possibility of fire or explosion, be careful when working around gasoline. Use only a nonflammable solvent, not gasoline, to clean parts. Keep cigarettes, sparks, and flames away from all fuel-related parts.
- Wear gloves when handling the propeller to protect your hands from sharp edges.

SERVICING YOUR OUTBOARD MOTOR

TOOL KIT AND EMERGENCY STARTER ROPE

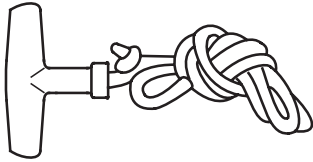

EMERGENCY STARTER ROPE

The following tools are supplied with the outboard motor for simple maintenance procedures and emergency repairs. An emergency starter rope is also supplied. Keep these items on the boat, so they will always be available if you need them.



8 mm WRENCH

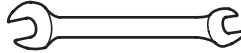

10 × 12 mm WRENCH



PHILIPS SCREWDRIVER

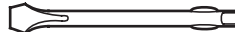

OIL CHECK SCREWDRIVER

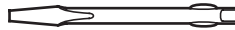

FLAT SCREWDRIVER



SCREWDRIVER GRIP



PLIERS



SPARK PLUG WRENCH



10 mm SOCKET WRENCH



SPARE CLIP

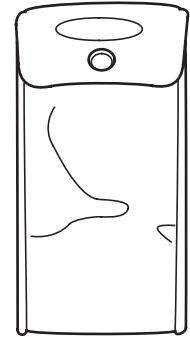

TOOL BAG

SERVICING YOUR OUTBOARD MOTOR

MAINTENANCE SCHEDULE

REGULAR SERVICE PERIOD (3) Perform at every indicated month or operating hour interval, whichever comes first. ITEM		Each use	After use	First month or 20 hrs.	Every 6 months or 100 hrs.	Every year or 200 hrs.
• Engine oil	Check level	○				
	Change			○	○	
Gear case oil	Change			○	○	
• Engine oil filter	Replace					○
Starter rope	Check				○	
Carburetor linkage	Check-adjust			○ (2)	○ (2)	
• Idling speed	Check-adjust			○ (2)	○ (2)	
• Valve clearance	Check-adjust			○ (2)		○ (2)
• Spark plugs	Check-adjust				○	
	Replace					○
Propeller and cotter pin	Check	○				
Lubrication	Grease			○ (1)	○ (1)	
• Fuel tank and tank filter	Clean					○

• Emission related items.

- (1) Lubricate more frequently when used in salt water.
- (2) These items should be serviced by an authorized Honda marine dealer, unless you have the proper tools and are mechanically proficient. Refer to the Honda shop manual for service procedures.
- (3) For professional/commercial use, log hours of operation to determine proper maintenance intervals.
- (4) When operating in salt water, turbid or muddy water, the engine should be flushed with clean water after each use.

SERVICING YOUR OUTBOARD MOTOR

REGULAR SERVICE PERIOD (3) Perform at every indicated month or operating hour interval, whichever comes first.		Each use	After use	First month or 20 hrs.	Every 6 months or 100 hrs.	Every year or 200 hrs.
● Fuel filter	Check				○	
	Replace					○
Thermostat	Check					○ (2)
● Fuel line	Check	○				
	Replace		Every 2 years (Replace if necessary) (2)			
Battery and cable connection	Check level-tightness	○				
Bolts and Nuts	Check-tightness			○ (2)	○ (2)	
● Crankcase breather tube	Check					○ (2)
Anode	Check	○				
Cooling water passages	Clean		○ (4)			

● Emission related items.

- (1) Lubricate more frequently when used in salt water.
- (2) These items should be serviced by an authorized Honda marine dealer, unless you have the proper tools and are mechanically proficient. Refer to the Honda shop manual for service procedures.
- (3) For professional/commercial use, log hours of operation to determine proper maintenance intervals.
- (4) When operating in salt water, turbid or muddy water, the engine should be flushed with clean water after each use.

SERVICING YOUR OUTBOARD MOTOR

MANUAL RELIEF VALVE (T type)

RIGHT STERN BRACKET

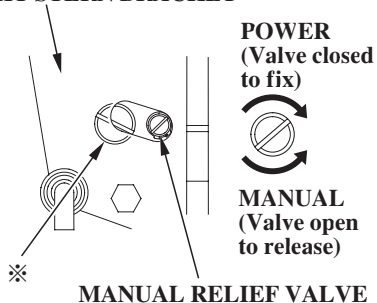

POWER
(Valve closed
to fix)



MANUAL
(Valve open
to release)



※ : Do not turn this screw. If this screw is turned hydraulic oil will bleed out of the power tilt system. Should this happen it will be necessary to contact your closest authorized Honda Marine dealer and have the system refilled.

The outboard motor can be tilted manually after opening the manual relief valve. This feature enables the outboard motor to be tilted when no battery is connected.

For manual tilting, use a flat screwdriver to turn the valve counterclockwise 2 and a half turns. Close the valve firmly after positioning the outboard motor.

Be sure the valve is closed before operating the outboard motor. If the valve is not closed, the outboard motor will tilt up when operated in reverse.

ENGINE COVER REMOVAL AND INSTALLATION

(FRONT)

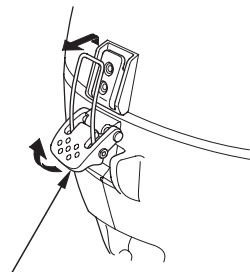

ENGINE COVER LATCH

(REAR)

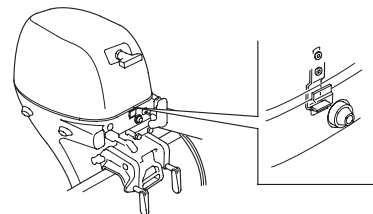

SERVICING YOUR OUTBOARD MOTOR

(REAR INSTALLATION)



The engine cover latch fastens the engine cover to the outboard motor.

To remove the engine cover, unlatch the engine cover latch, then lift the engine cover off the outboard motor.

To install the engine cover, place the cover on the outboard motor, then latch the engine cover latch securely.

Engine Oil Level Check

Check the engine oil level with the engine stopped and the outboard motor in the vertical position.

1. Unlatch and remove the engine cover.
2. Remove the dipstick and wipe it clean.

OIL LEVEL DIPSTICK

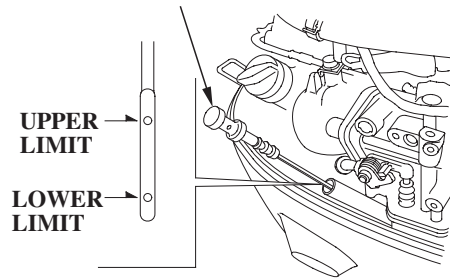

3. Insert the dipstick all the way in, then remove it and check the oil level shown on the dipstick.

OIL FILLER CAP

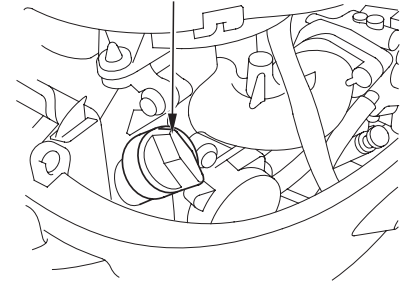

4. If the oil level is low, remove the oil filler cap, and add oil to reach the upper limit mark shown on the dipstick. Use the oil recommended on p. 68.

NOTICE

Running the engine with a low oil level can cause engine damage.

5. Install the oil filler cap and tighten it securely.
6. Install and lock the engine cover.

SERVICING YOUR OUTBOARD MOTOR

Engine Oil Change

An engine oil evacuation/filling device may be used to remove/add the engine oil.

Drain the used oil while the engine is warm. Warm oil drains quickly and completely.

1. Unlatch and remove the engine cover (p. 65).

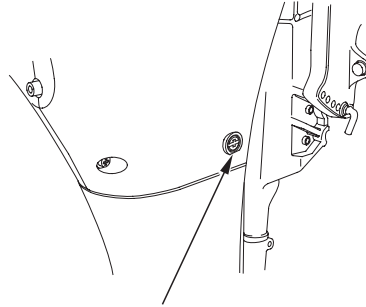

ENGINE OIL DRAIN SCREW

2. Remove the oil filler cap, and remove the engine oil drain screw.
3. Allow the used oil to drain completely, then reinstall the engine oil drain screw, and tighten it securely.

NOTICE

Improper disposal of engine oil can be harmful to the environment. If you change your own oil, please dispose of the used oil properly. Put it in a sealed container, and take it to a recycling center. Do not discard it in a trash bin or dump it on the ground.

4. With the outboard motor in a vertical position, fill to the upper limit mark on the dipstick (p. 65) with the recommended oil.

Engine oil refill capacity:

Without oil filter change:

1.1 US qt (1.0 ℓ)

With oil filter change:

1.4 US qt (1.3 ℓ)

5. Install the oil filler cap and tighten it securely.
6. Install and lock the engine cover.

SERVICING YOUR OUTBOARD MOTOR

Oil Filter Change

1. Drain the engine oil, and reinstall the drain screw (see Engine Oil Change on p. 66).
2. Unscrew the six bolts and remove the R. engine under cover.
3. Use a suitable tool to remove the oil filter, and thoroughly drain the filter into the used oil container.

USE A SUITABLE TOOL

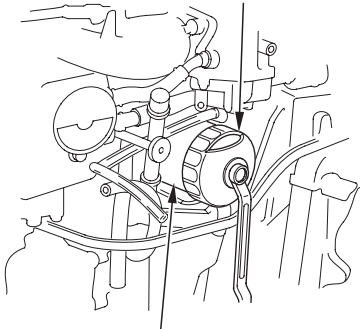

OIL FILTER

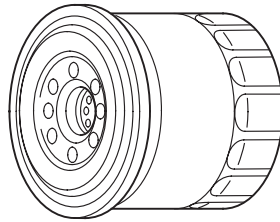

4. Clean the oil filter mounting base, and coat the gasket of the new oil filter with clean engine oil.

NOTICE

Use only a genuine Honda oil filter or a filter of equivalent quality specified for your model. Using the wrong filter, or a non-Honda filter which is not of equivalent quality, may cause engine damage.

5. Screw on the new filter by hand until it contacts the engine, then use a suitable tool to tighten the filter an additional $7/8$ turn.

OIL FILTER TIGHTENING TORQUE:
9 lbf-ft (12 N·m , 1.2 kgf·m)

6. Fill the crankcase with the specified amount (p. 66) of the recommended oil.
7. Start the engine and check for leaks.

NOTICE

Running the engine without water can cause serious engine damage. If you are changing the oil filter while the outboard motor is out of the water, place unit in water or supply adequate water to the water intakes before running the engine.

8. Stop the engine, and check the oil level as described on page 65 . If necessary, add oil to bring the oil level to the upper limit mark on the dipstick.

SERVICING YOUR OUTBOARD MOTOR

Engine Oil Recommendations

Oil is a major factor affecting performance and service life. Use 4-stroke automotive detergent oil.

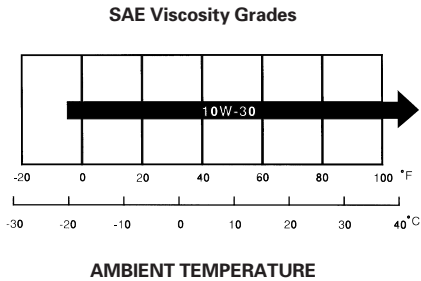

SAE 10W-30 is recommended for general use.

The SAE oil viscosity and service classification are in the API label on the oil container. Honda recommends that you use API SERVICE category SG, SH or SJ oil with the “starburst” certification mark displayed on the container.

Gear Oil Level Check

Check the gear oil level with the engine stopped and the outboard motor in the vertical position.

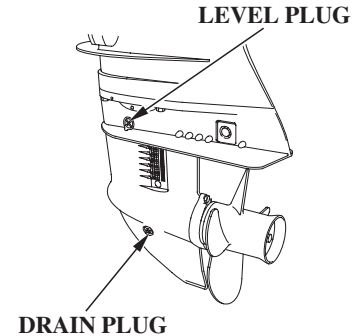

Remove the oil level plug and see whether oil flows from the oil level hole.

If oil flows from the oil level hole, the oil level is OK. Reinstall the plug and tighten it securely.

OIL LEVEL PLUG TORQUE:
2.6 lbf·ft (3.5 N·m , 0.36 kgf·m)

SERVICING YOUR OUTBOARD MOTOR

If no oil flows from the oil level hole, add the recommended oil following the procedure described in Gear Oil Change.

Gear Oil Change

Change the gear oil with the engine stopped and the outboard motor in the vertical position.

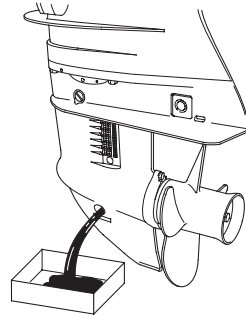

1. Place a suitable container below the oil drain hole to catch the used oil, then remove the oil level plug and oil drain plug.
2. Remove any metal particles from the magnetic end of the oil drain plug.

3. Allow the used oil to drain completely, then install an oil pump adapter in the oil drain hole.

If water or contaminated (milky-colored) oil flows out the drain hole when the plug is removed, have the outboard motor checked by an authorized Honda Marine dealer.

SERVICING YOUR OUTBOARD MOTOR

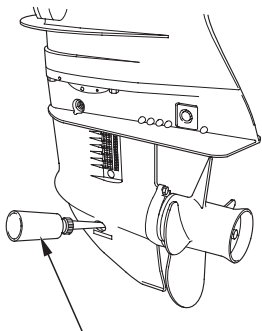

GEAR OIL BOTTLE

4. Add oil through the oil drain hole until it flows out the oil level hole, then install the oil level plug and the oil drain plug.

GEAR OIL CAPACITY:
0.301 US qt (0.285 ℓ)

Outboard motor SAE 90 hypoid
gear oil API Service classification
(GL-4 or GL-5)

OIL LEVEL PLUG TORQUE:
2.6 lbf·ft (3.5 N·m , 0.36 kgf·m)

Avoid losing more than 1 fl oz (30 cm³) while reinstalling the drain plug.

OIL DRAIN PLUG TORQUE:
2.6 lbf·ft (3.5 N·m , 0.36 kgf·m)

SERVICING YOUR OUTBOARD MOTOR

Lubrication Points

Wipe the outside of the engine with a cloth dipped in oil. Apply marine anticorrosion grease to the following parts:

Lubrication interval:

20 operating hours or a month after the date of purchase for initial, then every 100 operating hours or 6 months.

Apply anticorrosion oil to pivot surfaces where grease cannot penetrate.

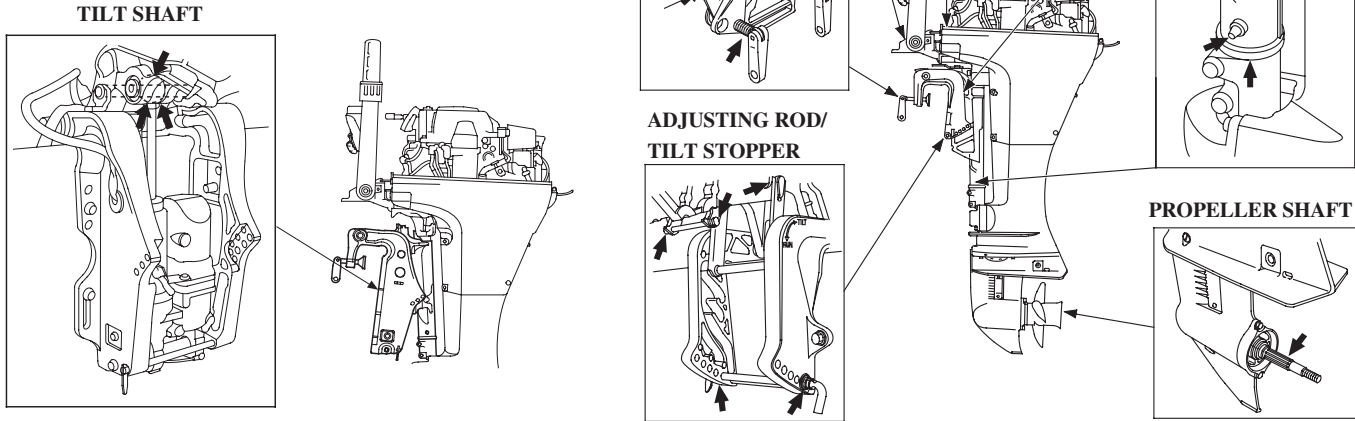

Apply Honda Marine Corrosion Inhibitor (or equivalent) to all areas under the engine cover except the belts.

SERVICING YOUR OUTBOARD MOTOR

Spark Plug Service

RECOMMENDED SPARK PLUGS:
CR5EH-9 (NGK)
U16FER9 (DENSO)

NOTICE

Incorrect spark plugs can cause engine damage.

1. Unlatch and remove the engine cover (p. 64).
2. Disconnect the spark plug caps from the spark plugs.
3. Remove the spark plugs with a spark plug wrench and screwdriver supplied in the tool kit.

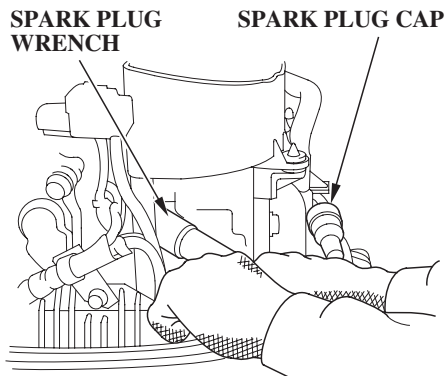

4. Inspect the spark plugs. Replace them if the electrodes are worn, or if the insulators are cracked or chipped. Clean the spark plugs with a wire brush if you are going to reuse them.

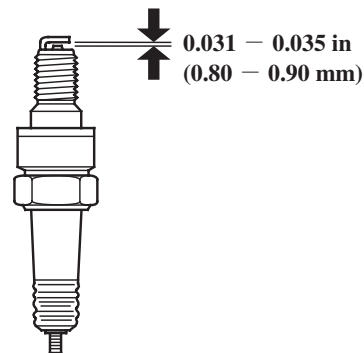

5. Measure the spark plug electrode gap with a suitable gauge. The gap should be 0.031 – 0.035 inches (0.80 – 0.90 mm).

SERVICING YOUR OUTBOARD MOTOR

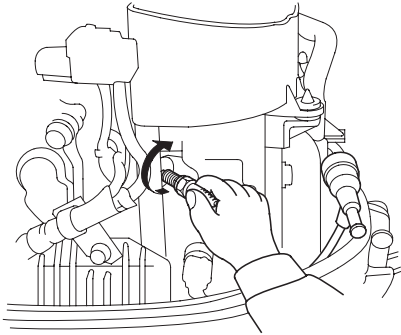

6. Install the spark plugs carefully, by hand, to avoid cross-threading.

7. After each spark plug seats, tighten with a spark plug wrench supplied in the tool kit to compress the sealing washer.

If reinstalling used spark plugs, tighten 1/8 - 1/4 turn after the spark plugs seat.

If installing new spark plugs, tighten 1/2 turn after the spark plugs seat.

NOTICE

Loose spark plugs can overheat and damage the engine.

Overtightening the spark plugs can damage the threads in the cylinder head.

8. Attach the spark plug caps.
9. Install and lock the engine cover.

SERVICING YOUR OUTBOARD MOTOR

REFUELING

Portable Fuel Tank

FUEL TANK CAPACITY:
3.2 US gal (12 ℓ)

Check the fuel gauge and refill the tank when necessary.

Remove the fuel tank from the boat for refueling.

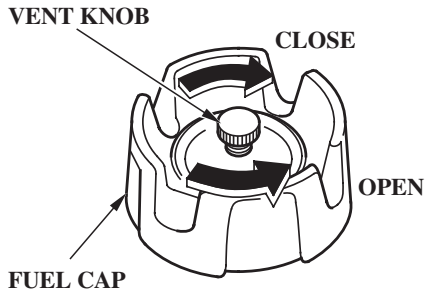

To refuel, turn the vent knob counterclockwise to the OPEN position, and unscrew the fuel tank cap.

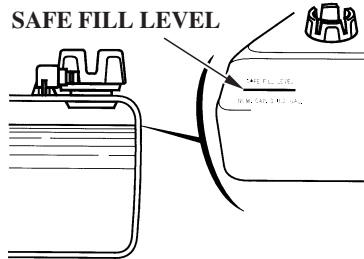
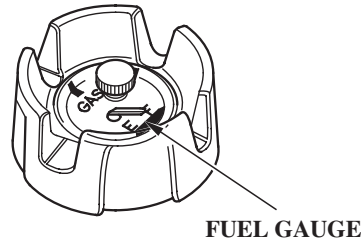

Refuel in a well-ventilated area. Fill the tank to the SAFE FILL LEVEL line.

After refueling, install the cap and tighten it securely. Turn the vent knob clockwise to the CLOSED position, and return the fuel tank to the boat.

⚠ WARNING

Gasoline is highly flammable and explosive.

You can be burned or seriously injured when handling fuel.

- Stop the engine and keep heat, sparks, and flame away.
- Handle fuel only outdoors.
- Wipe up spills immediately.

Never refill the fuel tank inside a building where gasoline fumes may reach flames or sparks. Keep gasoline away from appliance pilot lights, barbecues, electric appliances, power tools, etc.

Spilled fuel is not only a fire hazard, it causes environmental damage. Wipe up spills immediately.

FUEL RECOMMENDATIONS

Use unleaded gasoline with a pump octane rating of 86 or higher.

Your outboard motor is certified to operate on unleaded gasoline. Unleaded gasoline produces fewer engine and spark plug deposits and extends exhaust system life.

Never use stale or contaminated gasoline or an oil/gasoline mixture. Avoid getting dirt or water in the fuel tank.

Occasionally you may hear a light “spark knock” or “pinging” (metallic rapping noise) while operating under heavy loads. This is no cause for concern.

If spark knock or pinging occurs at a steady engine speed, under normal load, change brands of gasoline. If spark knock or pinging persists, see an authorized Honda marine dealer.

NOTICE

Running the engine with persistent spark knock or pinging can cause engine damage.

Running the engine with persistent spark knock or pinging is misuse, and the *Distributor's Limited Warranty* does not cover parts damaged by misuse.

Fuel Pump Filter Inspection and Replacement

The fuel pump filter is located under the engine cover, on the right side of the engine.

Water or sediment accumulated in the filter can cause loss of power or hard starting. To prevent engine malfunction, inspect the filter and replace when necessary.

⚠ WARNING

Gasoline is highly flammable and explosive.

You can be burned or seriously injured when handling fuel.

- Stop the engine and keep heat, sparks, and flame away.
- Handle fuel only outdoors.
- Wipe up spills immediately.

SERVICING YOUR OUTBOARD MOTOR

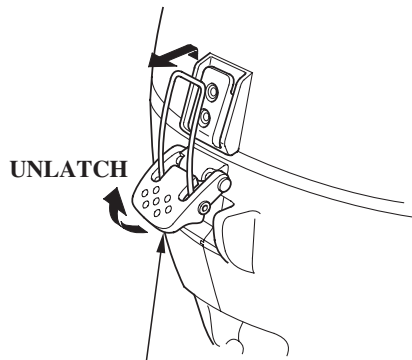

ENGINE COVER LATCH

1. Unlatch and remove the engine cover for access to the fuel pump filter.

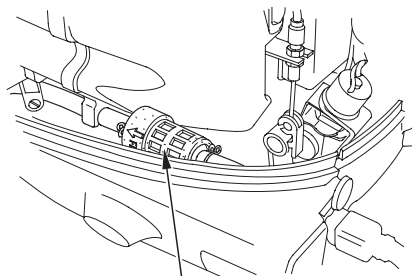

FUEL PUMP FILTER

2. Inspect the filter for water and/or sediment accumulation.

If the filter is OK, reinstall it. If water and/or sediment are present, replace the filter as described in the following steps. Always replace the filter at the scheduled replacement interval (p. 63).

3. Disconnect the fuel hose from the outboard motor, and place clamps on the fuel hoses on each side of the filter to prevent fuel leakage when the fuel hoses are disconnected.

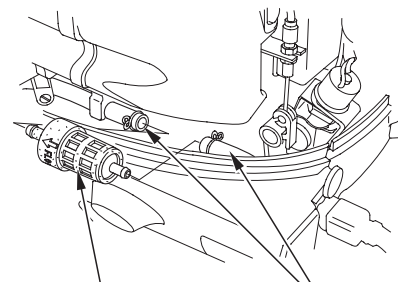

FUEL PUMP FILTER

FUEL HOSE

4. Remove the fuel tubes from the used filter, and discard the filter.

To ease tube removal, release the tube clips by squeezing the clip ends together with pliers while pulling off the tubes.

SERVICING YOUR OUTBOARD MOTOR

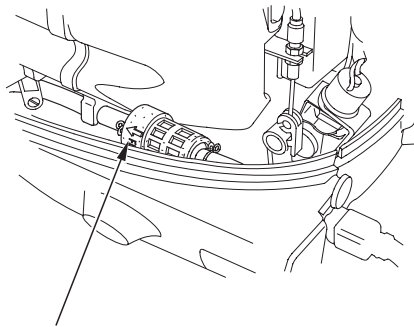

ARROW
(Fuel Flow Direction)

5. Install the new filter on the fuel hoses, with the fuel flow arrow pointing toward the fuel pump as shown. Fuel flow will be impeded if the filter is installed backward.
6. Remove the fuel tube clamps, and connect the fuel hose to the outboard motor. Check for leaks.
7. Install and lock the engine cover.

Portable Fuel Tank and Filter Cleaning

Fuel Tank

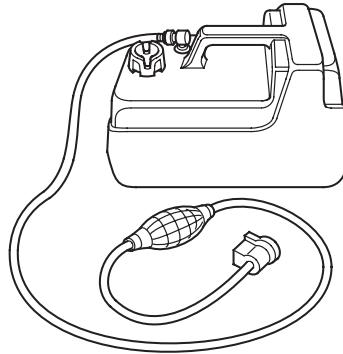

Empty the portable fuel tank into an approved gasoline container. Use a funnel to avoid spilling fuel. Rinse the fuel tank with nonflammable solvent to remove any accumulated sediment.

Fuel Tank Filter

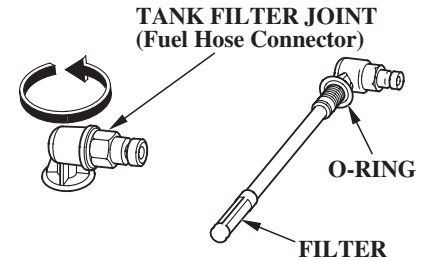

1. Unscrew the fuel hose connector by turning it counterclockwise, then remove the fuel hose connector and fuel filter from the tank.
2. Clean the filter in nonflammable solvent. Inspect the fuel tank filter and the connector O-ring. Replace them if damaged.
3. Reinstall the filter and hose connector in the fuel tank. Tighten the hose connector securely.

SERVICING YOUR OUTBOARD MOTOR

Recoil Starter Rope Inspection

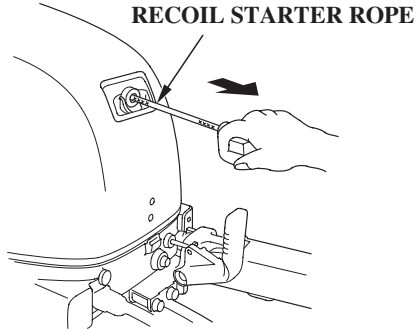

Inspect the recoil starter rope, and replace it if it becomes frayed.

Always keep the emergency starter rope on the boat in case the recoil starter rope fails.

Anode Replacement

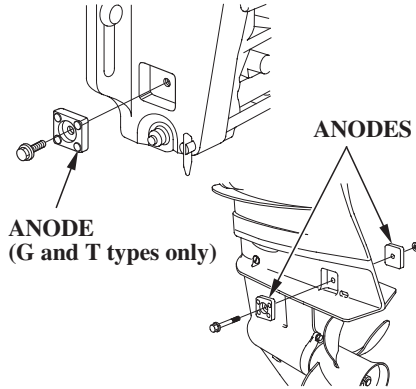

The anodes are located on each side of the gearcase and the stern bracket (G and T types only). They are made of a sacrificial material that helps to protect the outboard motor from corrosion.

Replace the anodes when they have been reduced to about half their original size, or if they are crumbling.

NOTICE

Painting or coating the anodes will defeat their purpose and will lead to rust and corrosion damage to the outboard motor. The anodes must be exposed to the water in order to protect the outboard motor.

SERVICING YOUR OUTBOARD MOTOR

Propeller Replacement

Before replacing the propeller, remove the clip from the engine stop switch to prevent any possibility of the engine being started while you are working with the propeller.

The propeller blades may have sharp edges, so wear heavy gloves to protect your hands.

Removal

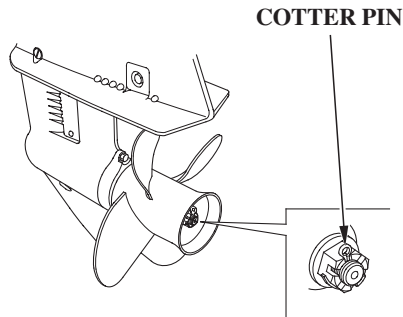

Remove the cotter pin, unscrew the castle nut, remove the washer, then remove the propeller and thrust washer.

Installation

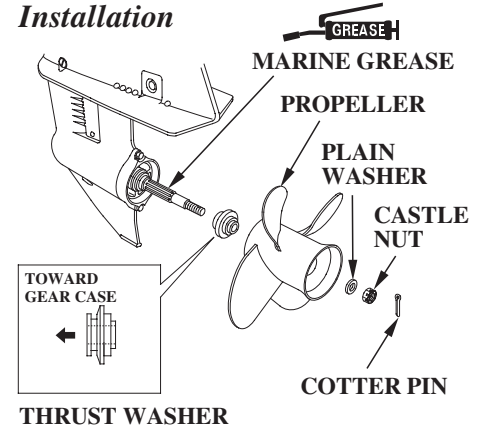

1. Install the propeller in the reverse order of removal.

NOTICE

- Install the thrust washer with the grooved side toward the gear case.
- Use a genuine Honda cotter pin.

STORAGE

STORAGE PREPARATION

Proper storage preparation is essential for keeping your outboard motor troublefree and looking good. The following steps will help to keep rust and corrosion from impairing your outboard motor's function and appearance, and will make the engine easier to start when you use the outboard motor again.

Cleaning and Flushing

Thoroughly clean and flush the outboard motor with fresh water after operation in dirty water or salt water.

Touch up any damaged paint, and coat areas that may rust with Honda Corrosion Inhibitor, or equivalent. Lubricate controls with a silicone spray lubricant.

Cleaning

Wash the outside of the outboard motor with clean, fresh water to

remove mud, salt, seaweed, etc.

Disengage the emergency engine stop switch clip from the engine stop switch, and pull the recoil starter rope several times to expel any water remaining in the water pump.

Flushing With the Honda Garden Hose Adapter (optional equipment)

1. Unlatch the engine cover latch and remove the engine cover (p. 65), and install the garden hose adapter.
2. Attach a garden hose from a fresh water faucet to the garden hose adapter.
3. Turn on the fresh water supply, and verify that there is good water pressure at the outboard motor.
4. Flush the engine with fresh water for at least 10 minutes.

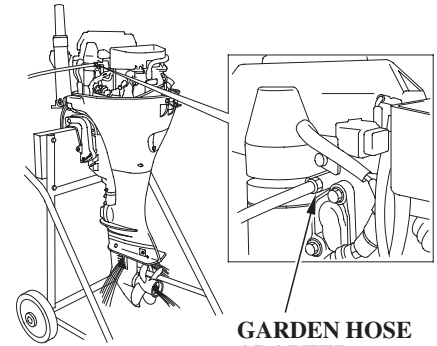

GARDEN HOSE ADAPTER

After flushing, remove the garden hose adapter, reinstall the engine cover.

Flushing Without the Honda Garden Hose Adapter

It is necessary to run the engine during the flushing procedure. For safety, remove the propeller from the outboard motor (p. 79).

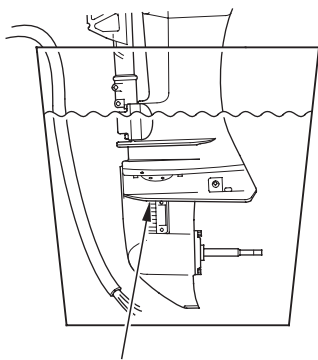

ANTIVENTILATION PLATE

1. Place a container under the outboard motor, and fill it with clean, fresh water. The water level must be at least 2 inches above the antiventilation plate.

NOTICE

Running the engine without good water circulation can cause overheating and water pump damage.

Damage caused by running the outboard motor without sufficient cooling water is not covered by the *Distributor's Limited Warranty*.

2. Start the engine and run in the N (neutral) position at low speed for at least 10 minutes.
3. After flushing, stop the engine, remove the water container, and reinstall the propeller (p. 79).

STORAGE

Fuel

Gasoline will oxidize and deteriorate in storage. Old gasoline will cause hard starting, and it leaves gum deposits that clog the fuel system. If the gasoline in your fuel tank and carburetor deteriorates during storage, you may need to have the carburetor and other fuel system components serviced or replaced.

The length of time that gasoline can be left in your fuel tank and carburetor without causing functional problems will vary with such factors as gasoline blend, your storage temperatures, and whether the fuel tank is partially or completely filled. The air in a partially filled fuel tank promotes fuel deterioration. Very warm storage temperatures accelerate fuel deterioration. Fuel deterioration problems may occur within a few months, or even less if the gasoline was not fresh when you filled the fuel tank.

You can extend fuel storage life by adding a gasoline stabilizer that is formulated for that purpose, or you can avoid fuel deterioration problems by draining all the fuel from the fuel tank and carburetor.

Adding a Fuel Stabilizer

When adding a fuel stabilizer, fill the fuel tank with fresh gasoline. If only partially filled, air in the tank will promote fuel deterioration during storage. If you keep an additional container of gasoline for refueling, be sure that it contains only fresh gasoline.

1. Add fuel stabilizer following the manufacturer's instructions.
2. After adding a fuel stabilizer, run the engine in water for 10 minutes to be sure that the treated gasoline has replaced the untreated gasoline in the carburetor.
3. Turn the engine OFF.

The *Distributor's Limited Warranty* does not cover fuel system damage or engine performance problems resulting from neglected storage preparation.

You can avoid fuel deterioration problems by draining the fuel tank and carburetors.

1. Disconnect the fuel hose from the outboard motor.

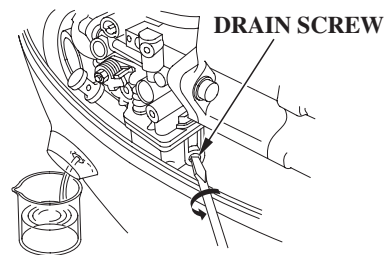

2. With the outboard motor in a vertical position, place an approved gasoline container below the fuel drain outlet, and use a funnel to avoid spilling fuel. Loosen the drain screw to drain fuel from the carburetor.

WARNING

Gasoline is highly flammable and explosive.

You can be burned or seriously injured when handling fuel.

- Stop the engine and keep heat, sparks, and flame away.
- Handle fuel only outdoors.
- Wipe up spills immediately.

3. After the fuel has drained from the carburetor, tighten the drain screw securely.

4. Drain the portable fuel tank into an approved gasoline container, or if you need to store fuel in the fuel tank, you can extend fuel storage life by filling the fuel tank with fresh gasoline and adding a fuel stabilizer that is formulated for that purpose. Firmly close the fuel cap vent knob.

STORAGE

Engine Oil

1. Change the engine oil and the oil filter (p. 66 – 67).
2. Remove the spark plugs (p. 72), and remove the clip from the emergency stop switch.
3. Pour a tablespoon (5 – 10 cm³) of clean engine oil into each cylinder.
4. Pull the starter rope several times to distribute the oil in the cylinders.
5. Reinstall the spark plugs (p. 73).

STORAGE PRECAUTIONS

Select a well-ventilated storage area. If possible, avoid storage areas with high humidity.

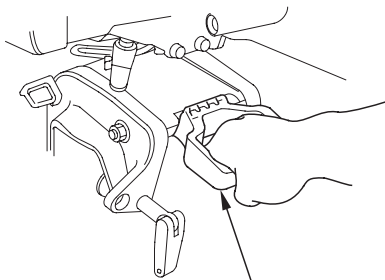

CARRYING HANDLE

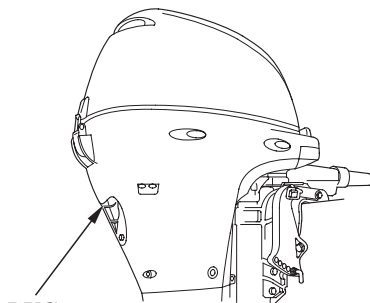

LUG

To carry the outboard motor, hold it by the carrying handle, or hold by the carrying handle and the lug beneath the engine cover latch, as shown.

NOTICE

Lifting the outboard motor by the engine cover, or using the installed outboard motor as a handle or lever to move the boat, can damage the outboard motor.

If your portable fuel tank contains gasoline, store it away from any appliance that operates with a flame, such as a furnace, water heater, or clothes dryer. Also avoid any area with a spark-producing electric motor, or where power tools are operated.

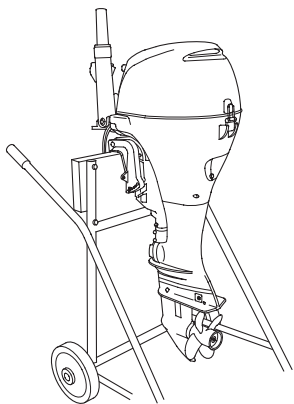

Store the outboard motor either vertically or horizontally with the tiller handle side up.

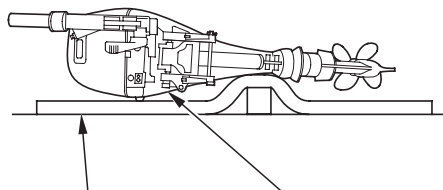

PROTECTOR CASE PROTECTOR

If storing horizontally, be sure to fold the tiller handle, and the outboard motor rests on its case protectors. Be sure all water has drained from the outboard motor before placing it on its side, so no residual water can enter the engine exhaust port.

NOTICE

Any other horizontal storage position may cause damage or oil leakage.

Cover the outboard motor to keep out dust. Do not use sheet plastic as a dust cover. A nonporous cover will trap moisture, promoting rust and corrosion.

REMOVAL FROM STORAGE

Check your outboard motor as described in the *BEFORE OPERATION* chapter of this manual.

If the cylinders were coated with oil during storage preparation, the engine may smoke briefly at startup. This is normal.

TRANSPORTING

WITH OUTBOARD MOTOR INSTALLED ON BOAT

When trailering a boat with the outboard motor attached, leave the engine in the normal running position, if possible, and tighten the steering friction lever securely (p. 50).

If there is insufficient road clearance in the normal running position, then tilt the outboard motor and use a motor support bar, or remove the outboard motor from the boat. Refer to the manufacturer's instructions for using a motor support bar.

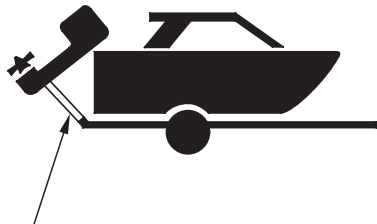

MOTOR SUPPORT BAR
(commercially available)

WITH OUTBOARD MOTOR REMOVED FROM BOAT

Secure the outboard motor in either the vertical or horizontal position shown on p. 85.

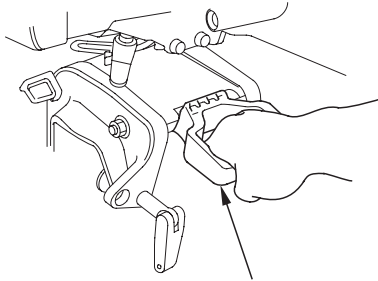

CARRYING HANDLE

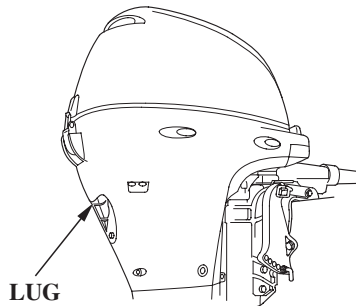

LUG

To carry, hold the outboard motor by the carrying handle, or hold by the carrying handle and the lug beneath engine cover lock lever, as shown.

NOTICE

Lifting the outboard motor by the engine cover, or using the installed outboard motor as a handle or lever to move the boat, can damage the outboard motor.

TAKING CARE OF UNEXPECTED PROBLEMS

ELECTRIC STARTER WILL NOT OPERATE	Possible Cause	Correction
1. Check battery.	Battery connections loose or corroded.	Clean and tighten battery connections.
	Battery discharged.	Recharge battery.
2. Check fuses.	Fuse(s) burnt out.	Replace fuse(s) (p. 92).
3. Use emergency starting procedure (p. 43), then take outboard motor to an authorized Honda Marine dealer, or refer to the shop manual.	Starter malfunction, switch malfunction, or electrical problem in the starting circuit.	Replace or repair faulty components as necessary.

TAKING CARE OF UNEXPECTED PROBLEMS

ENGINE WILL NOT START	Possible Cause	Correction
1. Check emergency stop switch clip.	Clip not inserted in stop switch.	Insert clip in stop switch.
2. Check control positions.	Gearshift lever or control lever not in neutral position.	Shift to neutral (p. 16 or p. 21).
	Choke OPEN (tiller-handle and manual choke type).	Pull choke knob to CLOSED position, unless engine is warm (p. 15).
	Throttle grip not in START position (tiller-handle type).	Turn throttle grip to START position (p. 39).
	Fast idle lever raised (side-mount type).	Leave fast idle lever OFF, unless engine is warm (p. 42).

TAKING CARE OF UNEXPECTED PROBLEMS

ENGINE WILL NOT START (continued)	Possible Cause	Correction
3. Check fuel.	Out of fuel.	Refuel (p. 74).
	Fuel vent closed (portable fuel tank).	Open fuel tank vent (p. 27).
	Fuel hose not primed.	Squeeze priming bulb (p. 38).
	Fuel pump filter or fuel tank filter clogged.	Replace fuel filters (p. 75).
	Bad fuel; boat stored without treating or draining gasoline, or refueled with bad gasoline.	Drain fuel tank and carburetors (p. 82). Refill with fresh gasoline (p. 74).
4. Remove and inspect spark plugs.	Spark plugs faulty, fouled or improperly gapped.	Clean, gap or replace spark plugs (p. 72).
	Spark plugs wet with fuel (flooded engine).	Dry and reinstall spark plugs. Start engine with choke and throttle open.
5. Take outboard motor to an authorized Honda Marine dealer, or refer to the shop manual.	Carburetor malfunction, fuel pump failure, ignition malfunction, stuck valves, etc.	Replace or repair faulty components as necessary.

TAKING CARE OF UNEXPECTED PROBLEMS

HARD STARTING OR STALLS AFTER STARTING	Possible Cause	Correction
1. Check control positions.	Choke OPEN (tiller-handle and manual choke type).	Pull choke knob to CLOSED position, unless engine is warm (p. 15).
	Throttle grip not in START position (tiller-handle type).	Turn throttle grip to START position (p. 39).
	Fast idle lever raised (side-mount type).	Leave fast idle lever OFF, unless engine is warm (p. 42).
2. Check fuel.	Fuel vent closed (portable fuel tank).	Open fuel tank vent (p. 27).
	Fuel hose not primed. Fuel pump filter or fuel tank clogged.	Squeeze priming bulb (p. 38). Replace fuel filters (p. 75).
	Bad fuel; boat stored without treating or draining gasoline, or refueled with bad fuel.	Drain fuel tank and carburetors (p. 82). Refill with fresh gasoline (p. 74).

TAKING CARE OF UNEXPECTED PROBLEMS

HARD STARTING OR STALLS AFTER STARTING (continued)	Possible Cause	Correction
3. Remove and inspect spark plugs.	Spark plugs faulty, fouled or improperly gapped.	Clean, gap or replace spark plugs (p. 72).
4. Take outboard motor to an authorized Honda Marine dealer, or refer to the shop manual.	Carburetor malfunction, fuel pump failure, ignition malfunction, etc.	Replace or repair faulty components as necessary.

ENGINE OVERHEATS	Possible Cause	Correction
1. Check water intake screens.	Water intake screens clogged.	Clean water intake screens.
2. Take outboard motor to an authorized Honda Marine dealer, or refer to the shop manual.	Faulty thermostat or water pump.	Replace or repair faulty components as necessary.

TAKING CARE OF UNEXPECTED PROBLEMS

BATTERY WILL NOT CHARGE AND ELECTRIC STARTER WILL NOT OPERATE

The battery-charging circuit and the electric starter relay circuit are protected by the 20-ampere fuse. If the fuse burns out, the engine will not charge the battery, and the electric starter will not operate. The engine can be started using the recoil starter or the emergency starter rope.

The ignition switch is also protected by the 20-ampere fuse. If the fuse burns out, the engine will not start or run, and the power tilt switch will not operate.

Fuse Replacement

1. With the engine stopped, remove the engine cover.
2. Remove the fuse case lid.

3. Remove and inspect the fuses. If a fuse is burnt out, install a replacement fuse of the specified rating. The outboard motor is supplied with spare fuses in the fuse holders.

DESIGNATED FUSE: 20A

NOTICE

Never use a fuse with a rating greater than specified. Serious damage to the electrical system could result.

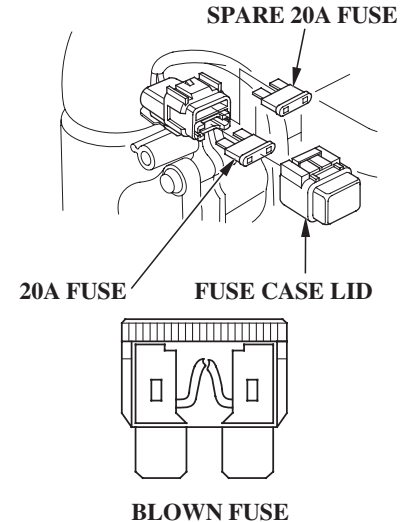

4. Reinstall the fuse case lid and the engine cover.

Before further operation, try to determine and correct the electrical problem that caused the fuse to burn out. An uncorrected electrical problem may cause the fuse to burn out again.

TAKING CARE OF UNEXPECTED PROBLEMS

OIL PRESSURE INDICATOR LIGHT GOES OFF AND ENGINE SPEED IS LIMITED

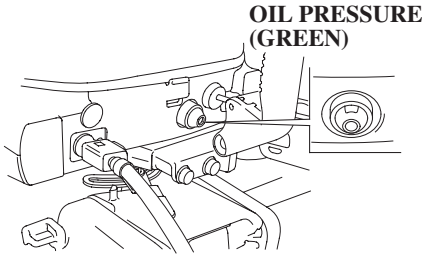

(tiller handle type)

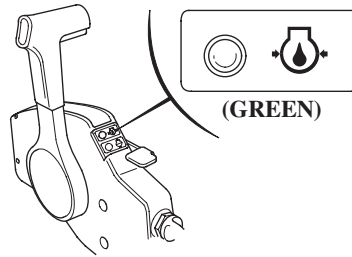

(remote control type)

If oil pressure becomes low, the green indicator light will go off, and the engine protection system will limit engine speed. If you are at cruising speed, engine speed will decrease automatically.

Remote-control types are equipped with a buzzer that sounds when the green indicator light goes off. The sound stops below the engine speed 1,400 rpm.

Low oil pressure may be the result of a low engine oil level, or there may be a problem with the engine lubrication system.

If the throttle is closed suddenly after full throttle operation, engine speed may drop below the specified idle rpm, and that could activate the engine protection system momentarily.

If low oil pressure activates the engine protection system, stop the engine, check the engine oil level (p. 65), and add oil if needed.

With the engine oil at the recommended level, restart the engine. If the lubrication system is OK, the green indicator light should come on within 30 seconds, and the engine will respond normally to throttle grip or control lever operation.

If the engine protection system remains activated after 30 seconds, return to the nearest boat landing, and have the outboard motor inspected by an authorized Honda marine dealer.

TAKING CARE OF UNEXPECTED PROBLEMS

OVERHEATING INDICATOR LIGHT COMES ON AND ENGINE SPEED IS LIMITED

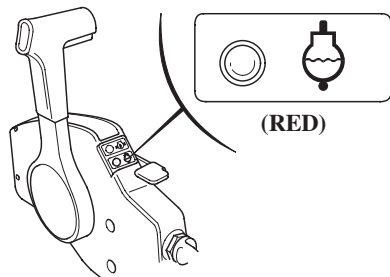

If the engine overheats, the red indicator light will come on, and the engine protection system will limit engine speed. If you are at cruising speed, engine speed will decrease automatically.

Remote-control types are equipped with a buzzer that sounds when the red indicator light comes on.

Engine overheating may be the result of clogged water intake screens, or there may be a problem with the cooling system thermostat or water pump.

If the engine is stopped after running at full throttle, and then restarted soon afterward, that could activate the engine protection system momentarily.

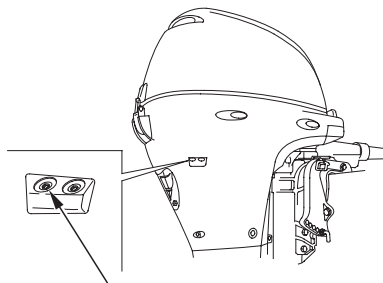

COOLING SYSTEM INDICATOR

If overheating activates the engine protection system, idle the engine in neutral, and check the cooling system indicator.

If water is flowing from the cooling system indicator, continue idling for 30 seconds. If the cooling system is OK, the red indicator light should go off within 30 seconds, and the engine will respond normally to throttle grip or control lever operation.

If there is no water flowing from the cooling system indicator, stop the engine, and tilt the outboard motor to inspect the water intake screens. If clogged, clean the water intake screens, return the outboard motor to the running position, restart the engine, and check the cooling system indicator again.

If there is still no water flowing from the cooling system indicator, or if the engine protection system remains activated after 30 seconds, return to the nearest boat landing, and have the outboard motor inspected by an authorized Honda marine dealer.

TAKING CARE OF UNEXPECTED PROBLEMS

SUBMERGED MOTOR

A submerged outboard motor must be serviced immediately after it is recovered from the water in order to minimize corrosion.

If there is a Honda marine dealership nearby, take the motor to the dealer immediately. If you are far from a dealership, proceed as follows:

1. Remove the engine cover, and rinse the outboard motor with fresh water to remove salt water, sand, mud, etc.
2. Drain the carburetor as described on p. 82 .

3. Change the engine oil and oil filter as described on p. 66 – 67. If there was water in the engine crankcase, or if the used engine oil showed signs of water contamination, then a second engine oil change should be performed after running the engine for half an hour.

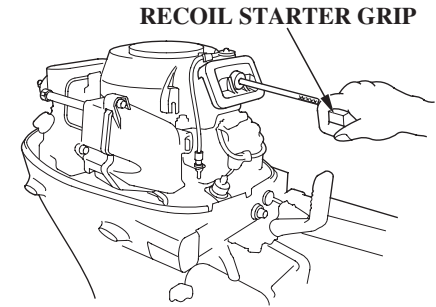

4. Remove the spark plugs (p. 72), and remove the clip from the emergency stop or engine switch. Pull the recoil starter grip, rotate the flywheel a few revolutions to completely expel any water from the cylinders.

If the engine was running when it submerged, there may be mechanical damage, such as bent connecting rods. If the engine binds when cranked, do not attempt to run the engine until it has been repaired.

TAKING CARE OF UNEXPECTED PROBLEMS

NOTICE

When cranking the engine with an open ignition circuit (spark plugs removed from the ignition circuit), remove the clip from the emergency or engine stop switch to prevent possible damage to the ignition system.

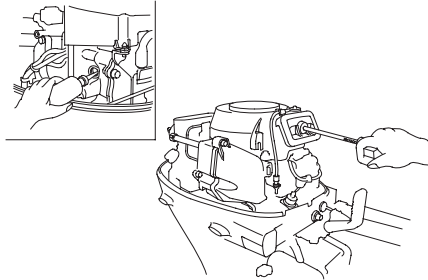

5. Pour a teaspoon of engine oil into each spark plug hole, then pull the recoil starter grip several times to lubricate the inside of the cylinders.
6. Reinstall the spark plugs, and put the emergency stop switch clip into the switch.

7. Attempt to start the engine.

If the engine fails to start, remove the spark plugs, clean and dry them, then reinstall the spark plugs and attempt to start the engine again.

If the engine starts, and no mechanical damage is evident, continue to run the engine for a half hour or longer. Be sure the water level is at least two inches above the antiventilation plate to avoid overheating and water pump damage.

8. As soon as possible, take the outboard motor to an authorized Honda Marine dealer for inspection and service.

TECHNICAL AND CONSUMER INFORMATION

TECHNICAL INFORMATION

Serial Number Locations

Record the product identification number and engine serial number in the space provided on this page. You will need these numbers when ordering parts, and when making technical or warranty inquiries (p. 106).

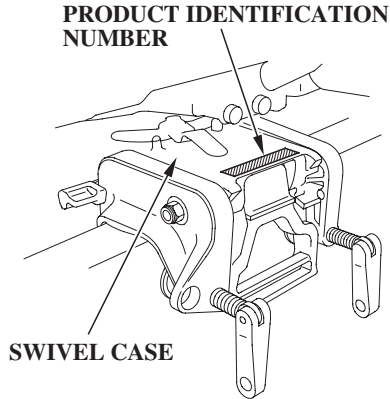

The product identification number is stamped on a plate attached on top of the stern bracket.

Product identification number:

ENGINE SERIAL NUMBER

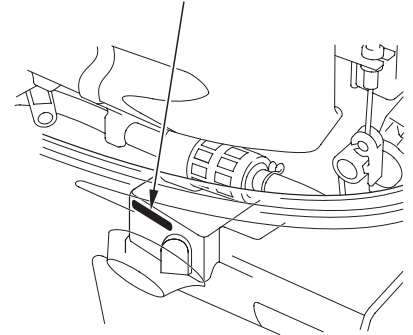

The engine serial number is stamped on the right front of the engine.

Engine serial number:

TECHNICAL AND CONSUMER INFORMATION

Carburetor Modification for High Altitude Operation

At high altitude, the standard carburetor air-fuel mixture will be too rich. Performance will decrease, and fuel consumption will increase. A very rich mixture will also foul the spark plugs and cause hard starting.

High altitude performance can be improved by specific modifications to the carburetors. If you always operate your outboard motor at altitudes above 5,000 feet (1,500 meters), have an authorized Honda marine dealer perform this carburetor modification.

Even with carburetor modification, engine horsepower will decrease about 3.5% for each 1,000-foot (300-meter) increase in altitude. The effect of altitude on horsepower will be greater than this if no carburetor modification is made.

NOTICE

When the carburetors have been modified for high altitude operation, the air-fuel mixture will be too lean for low altitude use. Operation at altitudes below 5,000 feet (1,500 meters) with modified carburetors may cause the engine to overheat and result in serious engine damage. For use at low altitudes, have an authorized Honda Marine dealer return the carburetors to original factory specifications.

TECHNICAL AND CONSUMER INFORMATION

Oxygenated Fuels

Some conventional gasolines are being blended with alcohol or an ether compound. These gasolines are collectively referred to as oxygenated fuels. To meet clean air standards, some areas of the United States and Canada use oxygenated fuels to help reduce emissions.

If you use an oxygenated fuel, be sure it is unleaded and meets the minimum octane rating requirement.

Before using an oxygenated fuel, try to confirm the fuel's contents. Some states/provinces require this information to be posted on the pump.

The following are the EPA-approved percentages of oxygenates:

ETHANOL: ethyl or grain alcohol; 10% by volume.

You may use gasoline containing up to 10% ethanol by volume. Gasoline containing ethanol may be marketed under the name "Gasohol".

MTBE: Methyl Tertiary Butyl Ether; 15% by volume.

You may use gasoline containing up to 15% MTBE by volume.

METHANOL: methyl or wood alcohol; 5% by volume.

You may use gasoline containing up to 5% methanol by volume, as long as it also contains cosolvents and corrosion inhibitors to protect the fuel system. Gasoline containing more than 5% methanol by volume may cause starting and/or performance problems. It may also

damage metal, rubber, and plastic parts of your fuel system.

If you notice any undesirable operating symptoms, try another service station, or switch to another brand of gasoline.

Fuel system damage or performance problems resulting from the use of an oxygenated fuel containing more than the percentages of oxygenates mentioned above are not covered under warranty.

TECHNICAL AND CONSUMER INFORMATION

Emission Control System Information

Source of Emissions

The combustion process produces carbon monoxide, oxides of nitrogen, and hydrocarbons. Control of hydrocarbons and oxides of nitrogen is very important because, under certain conditions, they react to form photochemical smog when subjected to sunlight. Carbon monoxide does not react in the same way, but it is toxic.

Honda utilizes lean carburetor settings and other systems to reduce the emissions of carbon monoxide, oxides of nitrogen, and hydrocarbons.

The U.S. and California Clean Air Acts

EPA and California regulations require all manufacturers to furnish written instructions describing the operation and maintenance of emission control systems.

The following instructions and procedures must be followed in order to keep the emissions from your Honda engine within the emission standards.

Tampering and Altering

Tampering with or altering the emission control system may increase emissions beyond the legal limit. Among those acts that constitute tampering are:

- Removal or alteration of any part of the intake, fuel, or exhaust systems.
- Alterations that would cause the engine to operate outside its design parameters.

Problems That May Affect Emissions

If you are aware of any of the following symptoms, have your engine inspected and repaired by your servicing dealer.

- Hard starting or stalling after starting.
- Rough idle.
- Misfiring or backfiring under load.
- Afterburning (backfiring).
- Black exhaust smoke or high fuel consumption.

Replacement Parts

The emission control systems on your Honda engine were designed, built, and certified to conform with EPA and California emission regulations. We recommend the use of genuine Honda parts whenever you have maintenance done. These original-design replacement parts are manufactured to the same standards as the original parts, so you can be confident of their performance. The use of replacement parts that are not of the original design and quality may impair the effectiveness of your emission control system.

A manufacturer of an aftermarket part assumes the responsibility that the part will not adversely affect emission performance. The manufacturer or rebuilder of the part must certify that use of the part will not result in a failure of the engine to comply with emission regulations.

Maintenance

Follow the maintenance schedule on p. 62. Remember that this schedule is based on the assumption that your machine will be used for its designed purpose. Sustained high-load operation, or use in unusual conditions, will require more frequent service.

TECHNICAL AND CONSUMER INFORMATION

Star Label

A Star label was applied to this outboard motor in accordance with the requirements of the California Air Resources Board.

The Star Label means Cleaner Marine Engine

This engine has been certified as a:



The Symbol for Cleaner Marine Engines:

Cleaner Air and Water - for healthier lifestyle and environment.

Better Fuel Economy - burns up to 30 - 40 percent less gas and oil than conventional carbureted two-stroke engines, saving money and resources.

Longer Emission Warranty - protects consumer for worry free operation.

TECHNICAL AND CONSUMER INFORMATION



One Star Low Emission

The one-star label identifies engines that meet the Air Resources Board's Personal Watercraft and Outboard marine engine 2001 exhaust emission standards. Engines meeting these standards have 75% lower emissions than conventional carbureted two-stroke engines. These engines are equivalent to the U.S.EPA's 2006 standards for marine engines.



Two Stars Very Low Emission

The two-star label identifies engines that meet the Air Resources Board's Personal Watercraft and Outboard marine engine 2004 exhaust emission standards. Engines meeting these standards have 20% lower emissions than One Star-Low Emission engines.



Three Stars Ultra Low Emission

The three-star label identifies engines that meet the Air Resources Board's Personal Watercraft and Outboard marine engine 2008 exhaust emission standards or the Sterndrive and inboard marine engine 2003-2008 exhaust emission standards. Engines meeting these standards have 65% lower emissions than One Star-Low Emission engines.



Four Stars Super Ultra Low Emission

The four-star label identifies engines that meet the Air Resources Board's Sterndrive and Inboard marine engine 2009 exhaust emission standards. Personal Watercraft and Outboard marine engines may also comply with these standards. Engines meeting these standards have 90% lower emissions than One Star-Low Emission engines.

Cleaner Watercraft - Get the Facts
1-800-END-SMOG
www.arb.ca.gov

TECHNICAL AND CONSUMER INFORMATION

Specifications

MODEL		BF15D/BFP15D						
Description Code		BALJ						
Type		H	G	HS	HG	HT	R	RT
Overall length		25.6 in (650 mm)					25.2 in (640 mm)	
Overall width		13.8 in (350 mm)						
Overall height	S	43.7 in (1,110 mm)						
	L	48.8 in (1,240 mm)						
	X	54.3 in (1,380 mm)						
Transom height	S	17.0 in (433 mm)						
	L	22.2 in (563 mm)						
	X	27.7 in (703 mm)						
Weight	S	102.5 lbs (46.5 kg)	_____	110.2 lbs (50.0 kg)	125.7 lbs (57.0 kg)	129.0 lbs (58.5 kg)	_____	127.9 lbs (58.0 kg)
	L	109.1 lbs (49.5 kg)	122.4 lbs (55.5 kg)	116.8 lbs (53.0 kg)	129.0 lbs (58.5 kg)	133.4 lbs (60.5 kg)	114.6 lbs (52.0 kg)	131.2 lbs (59.5 kg)
	X	114.6 lbs (52.0 kg)	_____	_____	134.5 lbs (61.0 kg)	138.9 lbs (63.0 kg)	_____	136.7 lbs (62.0 kg)
Rated power		11.2 kW (15 HP)						
Full throttle range		4,500 – 5,500 rpm						
Engine type		4 stroke OHC in-line 2 cylinder, water-cooled						
Displacement		21.4 cu-in (350 cm ³)						
Spark plug gap		0.031 – 0.035 in (0.80 – 0.90 mm)						
Starter system		Recoil starter			Recoil starter, Electric starter			
Ignition system		C.D.I						
Lubrication system		Trochoid pump pressure lubrication						
Specified oil		Engine: API Service classification (SG, SH, SJ) SAE 10W-30 Gear case: API Service classification (GL-4/5) SAE 90 Hypoind gear oil						

Honda outboards are power rated in accordance with NMMA procedures and using the ICOMIA standard 28/23.

Oil capacity	Engine: 1.4 US qt (1.3 ℓ) Gear case: 0.301 US qt (0.285 ℓ)		
CARB star label	ULTRA · LOW EMISSION		
D.C. output	12V – 6A	12V – 12A	12V – 12A
Cooling system	Water cooling with thermostat		
Exhaust system	Water exhaust		
Spark plugs	CR5EH-9 (NGK) , U16FER9 (DENSO)		
Fuel pump	Diaphragm type fuel pump		
Fuel	Automotive unleaded gasoline (91 research octane, 86 pump octane, or higher)		
Tank capacity	3.2 US gal (12 ℓ)		
Gear change	Forward-Neutral-Reverse (dog type)		
Steering angle	45° right and left		
Transom angle	(except G and T types): 5 stages (4°, 8°, 12°, 16°, 20°)		
	(G and T types): 4 stages (8°, 12°, 16°, 20°)		
Tilt angle	(S handle type, except G and T types): 3 stages adjustment (30°, 45° and 71°)		
	(L and X handle types, and R types, except G and T types): 3 stages adjustment (30°, 45° and 72°) (G and T types): 68°		
Remote control steering system	_____		Motor-mounted

Tune Up

Spark plug gap	0.031 – 0.035 in (0.80 – 0.90 mm)	Refer to page 72.
Idle speed	900 ± 50 rpm	See shop manual
Valve clearance (cold)	IN: 0.17 ± 0.02 mm EX: 0.23 ± 0.02 mm	See shop manual
Other specifications	No other adjustments needed.	

Honda outboards are power rated in accordance with NMMA procedures and using the ICOMIA standard 28/23.

TECHNICAL AND CONSUMER INFORMATION

Specifications

MODEL	BF20D/BFP20D							
Description Code	BAMJ							
Type	H	G	HS	HG	HT	R	RT	
Overall length	25.6 in (650 mm)					25.2 in (640 mm)		
Overall width	13.8 in (350 mm)							
Overall height	S	43.7 in (1,110 mm)						
	L	48.8 in (1,240 mm)						
	X	54.3 in (1,380 mm)						
Transom height	S	17.0 in (433 mm)						
	L	22.2 in (563 mm)						
	X	27.7 in (703 mm)						
Weight	S	102.5 lbs (46.5 kg)	_____	110.2 lbs (50.0 kg)	125.7 lbs (57.0 kg)	129.0 lbs (58.5 kg)	111.3 lbs (50.5 kg)	127.9 lbs (58.0 kg)
	L	109.1 lbs (49.5 kg)	122.4 lbs (55.5 kg)	116.8 lbs (53.0 kg)	129.0 lbs (58.5 kg)	133.4 lbs (60.5 kg)	114.6 lbs (52.0 kg)	131.2 lbs (59.5 kg)
	X	_____	_____	122.4 lbs (55.5 kg)	134.5 lbs (61.0 kg)	138.9 lbs (63.0 kg)	_____	136.7 lbs (62.0 kg)
Rated power	14.9 kW (20 HP)							
Full throttle range	5,000 – 6,000 rpm							
Engine type	4 stroke OHC in-line 2 cylinder, water-cooled							
Displacement	21.4 cu-in (350 cm ³)							
Spark plug gap	0.031 – 0.035 in (0.80 – 0.90 mm)							
Starter system	Recoil starter			Recoil starter, Electric starter				
Ignition system	C.D.I							
Lubrication system	Trochoid pump pressure lubrication							
Specified oil	Engine: API Service classification (SG, SH, SJ) SAE 10W-30 Gear case: API Service classification (GL-4/5) SAE 90 Hypoind gear oil							

Honda outboards are power rated in accordance with NMMA procedures and using the ICOMIA standard 28/23.

Oil capacity	Engine: 1.4 US qt (1.3 ℓ) Gear case: 0.301 US qt (0.285 ℓ)		
CARB star label	ULTRA · LOW EMISSION		
D.C. output	12V – 6A	12V – 12A	12V – 12A
Cooling system	Water cooling with thermostat		
Exhaust system	Water exhaust		
Spark plugs	CR5EH-9 (NGK) , U16FER9 (DENSO)		
Fuel pump	Diaphragm type fuel pump		
Fuel	Automotive unleaded gasoline (91 research octane, 86 pump octane, or higher)		
Tank capacity	3.2 US gal (12 ℓ)		
Gear change	Forward-Neutral-Reverse (dog type)		
Steering angle	45° right and left		
Transom angle	(except G and T types): 5 stages (4°, 8°, 12°, 16°, 20°)		
	(G and T types): 4 stages (8°, 12°, 16°, 20°)		
Tilt angle	(S handle type, except G and T types): 3 stages adjustment (30°, 45° and 71°) (L and X handle types, and R types, except G and T types): 3 stages adjustment (30°, 45° and 72°) (G and T types): 68°		
Remote control steering system	_____		Motor-mounted

Tune Up

Spark plug gap	0.031 – 0.035 in (0.80 – 0.90 mm)	Refer to page 72.
Idle speed	900 ± 50 rpm	See shop manual
Valve clearance (cold)	IN: 0.17 ± 0.02 mm EX: 0.23 ± 0.02 mm	See shop manual
Other specifications	No other adjustments needed.	

Honda outboards are power rated in accordance with NMMA procedures and using the ICOMIA standard 28/23.

TECHNICAL AND CONSUMER INFORMATION

CONSUMER INFORMATION

Honda Publications

These publications will give you additional information for maintaining and repairing your outboard motor. You may purchase them from your Honda marine dealer.

Shop Manual

This manual covers complete maintenance and overhaul procedures. It is intended to be used by a skilled technician.

Parts Catalog

This manual provides complete, illustrated parts lists.

Warranty Service Information

Honda Marine dealership personnel are trained professionals. They should be able to answer any question you may have. If you encounter a problem that your dealer does not solve to your satisfaction, please discuss it with the dealership's management. The Service Manager or General Manager can help. Almost all problems are solved in this way.

If you are dissatisfied with the decision made by the dealership's management, contact the Honda Marine Customer Relations Office. You can write:

American Honda Motor Co., Inc.
Marine Division
Customer Relations Office
4900 Marconi Drive
Alpharetta, Georgia 30005-8847

Or telephone: (770) 497-6400

When you write or call, please give us this information:

- Model and serial numbers (p. 97)
- Name of the dealer who sold the outboard motor to you
- Name and address of the dealer who services your outboard motor
- Date of purchase
- Your name, address, and telephone number
- A detailed description of the problem

INDEX

Anodes.....	26	Cooling System Indicator.....	26
Replacement.....	78	CRUISING.....	51
ARE YOU READY TO GET UNDER WAY ?	33	Electric Starter Button (models equipped with electric starter).....	17
ATTACHMENT.....	29	EMERGENCY STARTING.....	43
Automatic Choke		Emission Control System Information	100
(models equipped with electric starter).....	26	Engine	
BATTERY CONNECTIONS.....	30	Cover	
BATTERY WILL NOT CHARGE AND		Latch.....	23
ELECTRIC STARTER WILL NOT		REMOVAL AND INSTALLATION.....	64
OPERATE.....	92	Oil	
BEFORE OPERATION.....	33	Change.....	66
BOAT TRANSOM REQUIREMENTS	28	Level Check	65
BREAK-IN PROCEDURE.....	35	Recommendations.....	68
		Stop Switch and Switch Clip	15
Carburetor Modification for High Altitude		Fast Idle Lever.....	20
Operation.....	98	Fuel	
Cleaning and Flushing.....	80	Cap Vent Knob.....	27
Choke Knob (H type manual choke)	15	HOSE CONNECTIONS.....	37
COMPONENT AND CONTROL LOCATIONS	12	Gauge.....	24
CONSUMER INFORMATION	108	PRIMING	38
Honda Publications	108	Priming Bulb	27
Warranty Service Information	108	RECOMMENDATIONS.....	75
CONTROLS.....	15	Pump Filter Inspection and Replacement	75
CONTROLS AND FEATURE IDENTIFICATION			
CODES.....	10		
CONTROLS AND FEATURES	10		

INDEX

Gear Oil		
Change.....	69	
Level Check.....	68	
GEARSHIFTING AND THROTTLE OPERATION ...	48	
H Type (tiller handle).....	48	
R Type (remote control).....	49	
Gearshift Lever.....	16	
Gearshift/Trottle Control Lever.....	21	
Ignition Switch.....	19	
IMPORTANT SAFETY INFORMATION.....	7	
INDICATORS.....	25	
INSTALLATION.....	28	
INSTALLATION POSITION.....	28	
INSTRUMENTS.....	24	
IS YOUR OUTBOARD MOTOR READY TO GO ?	33	
Lubrication Points.....	71	
MAINTENANCE SAFETY.....	60	
MAINTENANCE SCHEDULE.....	62	
Manual Relief Valve (T type).....	22, 64	
MOORING, BEACHING, LAUNCHING.....	57	
Oil filter Change.....	67	
Oil Pressure Indicator (R type) (H type).....	25	
OIL PRESSURE INDICATOR LIGHT GOES OFF AND ENGINE SPEED IS LIMITED.....	93	
OPERATION.....	35	
OTHER FEATURES.....	26	
OUTBOARD MOTOR SAFETY.....	7	
Overheating Indicator (R type).....	25	
OVERHEATING INDICATOR LIGHT COMES ON AND ENGINE SPEED IS LIMITED (remote control type).....	94	
Overrev Limiter.....	26	
Oxygenated Fuels.....	99	

PORTABLE FUEL TANK.....	27, 37	SAFE OPERATING PRECAUTIONS	35
Portable Fuel Tank and Filter Cleaning	77	SAFETY LABEL LOCATIONS	9
POWER REQUIREMENTS.....	28	Serial Number Locations.....	97
Power Tilt Switch (T type).....	18, 22	SERVICING YOUR OUTBOARD MOTOR.....	59
Propeller Replacement	79	SHALLOW WATER OPERATION	54
		Spark Plug Service	72
Recoil Starter		Specifications	104
Grip.....	17	Star Label	102
Rope Inspection.....	78	STARTING THE ENGINE	38
REFUELING.....	74	H Type (tiller handle).....	38
REMOVAL FROM STORAGE	85	R Type (remote control).....	41
		STEERING.....	50
		H Type (tiller handle).....	50
		R Type (remote control).....	50
		Steering Friction Lever.....	17
		STOPPING THE ENGINE.....	46
		Emergency Engine Stopping.....	46
		Normal Engine Stopping.....	46
		STORAGE	80
		STORAGE PRECAUTIONS.....	84
		STORAGE PREPARATION.....	80
		Fuel.....	82
		Engine oil	84
		SUBMERGED MOTOR.....	95
		Switch Clip and Emergency Stop Switch	19

INDEX

Tachometer (optional equipment).....	24
TAKING CARE OF UNEXPECTED PROBLEMS.....	87
TECHNICAL AND CONSUMER INFORMATION...	97
TECHNICAL INFORMATION.....	97
THE IMPORTANCE OF MAINTENANCE	59
Throttle Friction Adjuster	16
Throttle Grip.....	16
Tilt	
Lever (except G and T types).....	24
Lever (G type).....	18
Lever (G and T types)	23
TOOL KIT AND EMERGENCY STARTER ROPE ...	61
Transom Angle Adjusting Rod	23
TRANSOM ANGLE ADJUSTMENT	30, 36
TRANSPORTING	86
WITH OUTBOARD MOTOR INSTALLED	
ON BOAT	86
WITH OUTBOARD MOTOR REMOVED	
FROM BOAT	86
WIRING DIAGRAMS	113

WIRING DIAGRAM

TILER HANDLE AND GAS-ASSISTED TILT TYPE (with recoil starter and 6A charge coil)

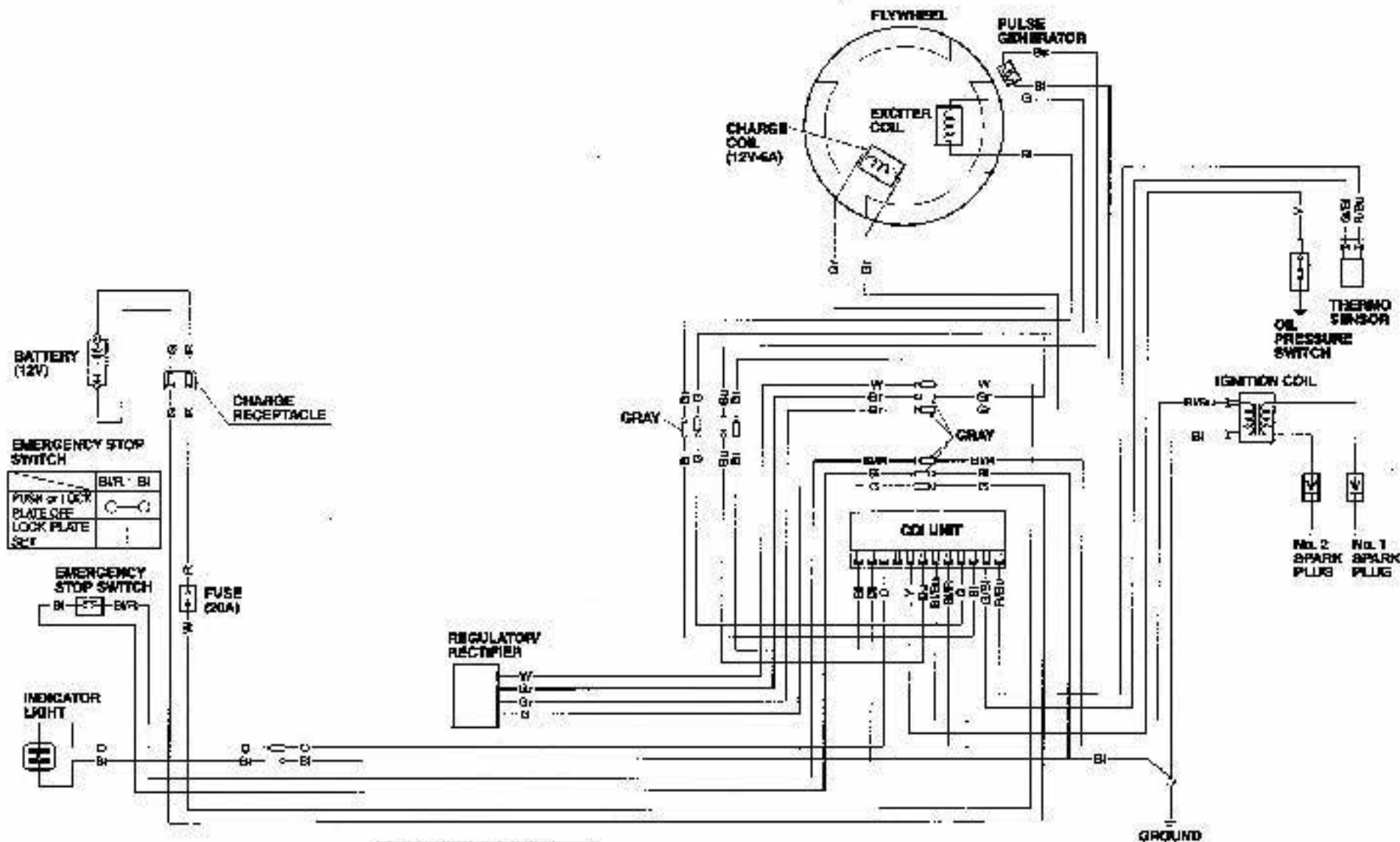

WIRING DIAGRAM

TILLER HANDLE AND GAS-ASSISTED TILT TYPE (with electric starter, and except power till type)

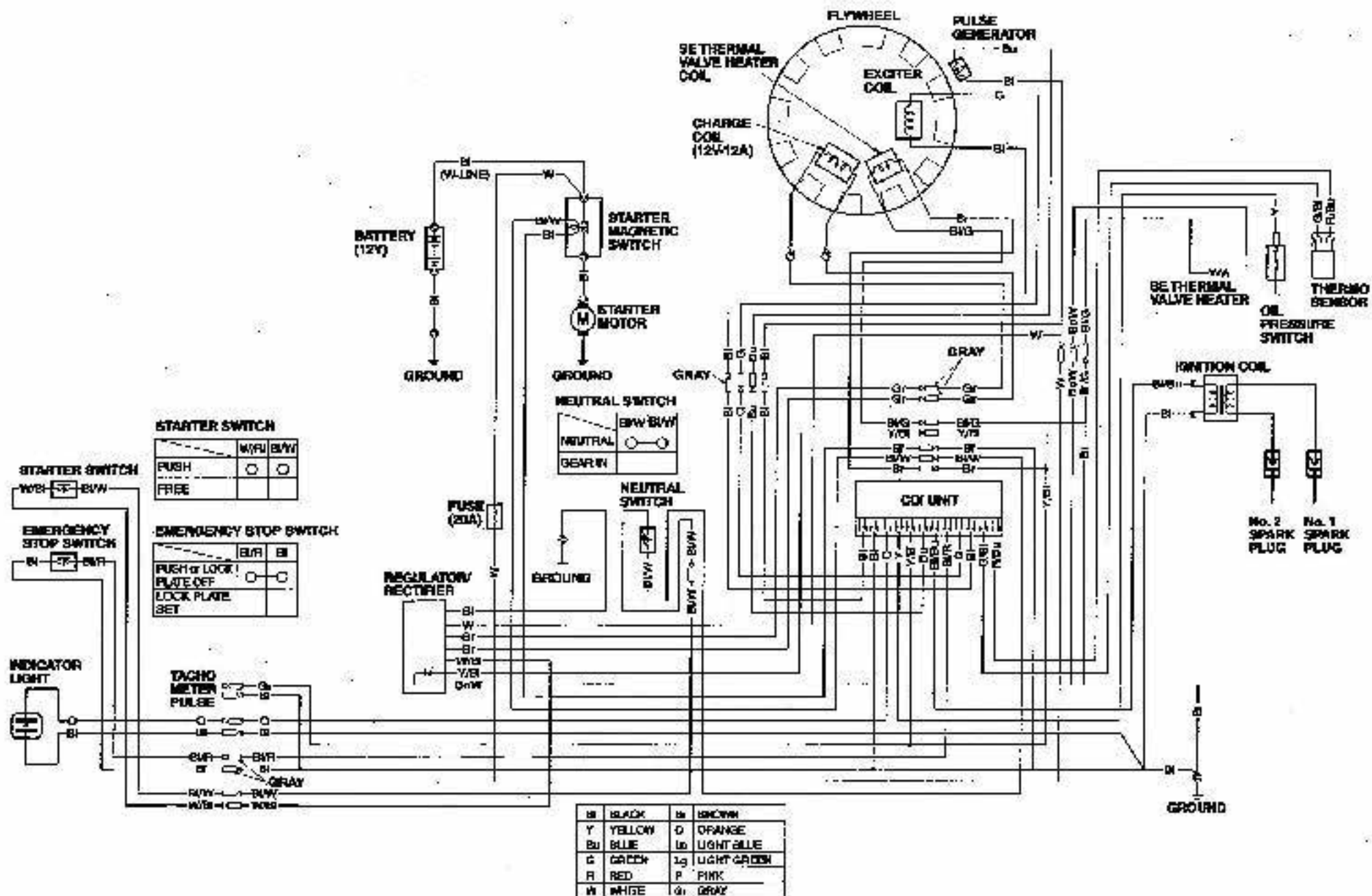

TITLER HANDLE TYPE (with electric starter, and power tilt type)

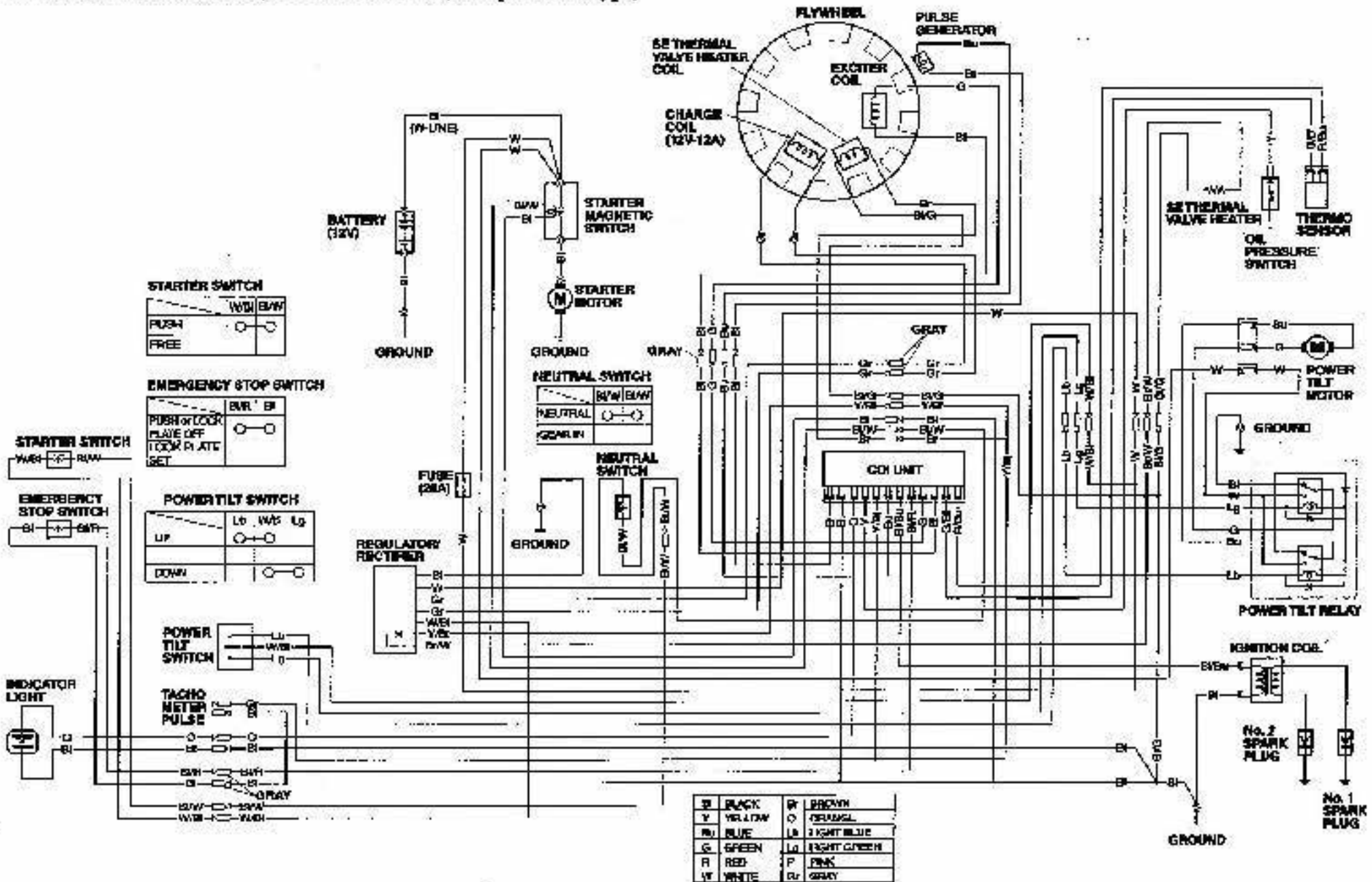

WIRING DIAGRAM

REMOTE CONTROL TYPE (except power tilt type)

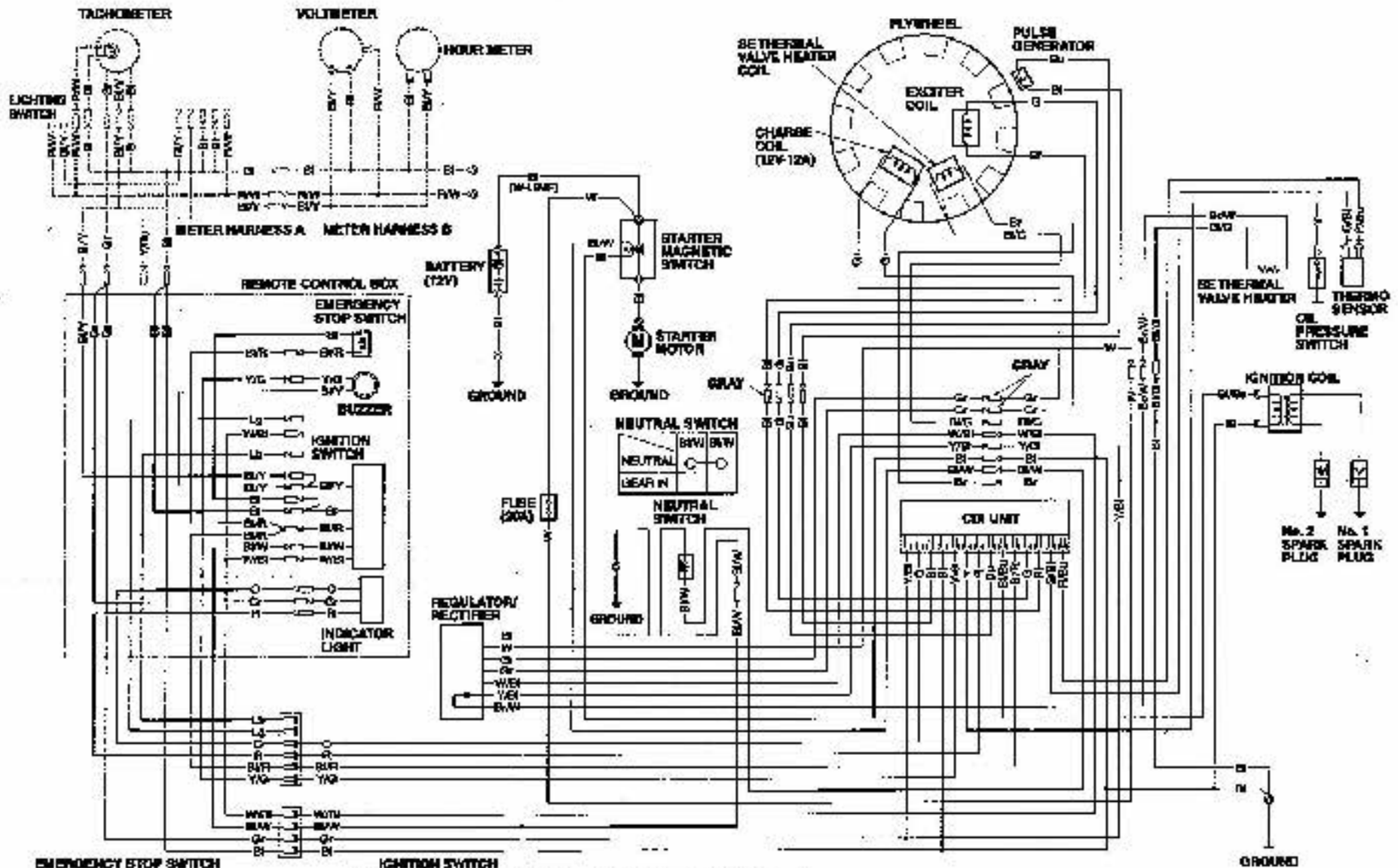

EMERGENCY STOP SWITCH

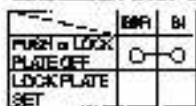

IGNITION SWITCH

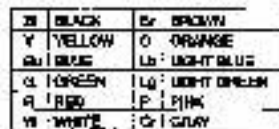
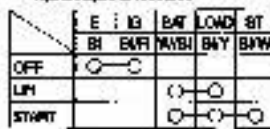

REMOTE CONTROL AND POWER TILT TYPE

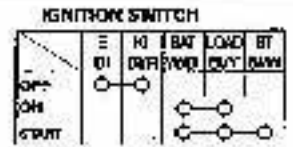
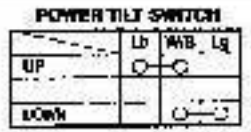
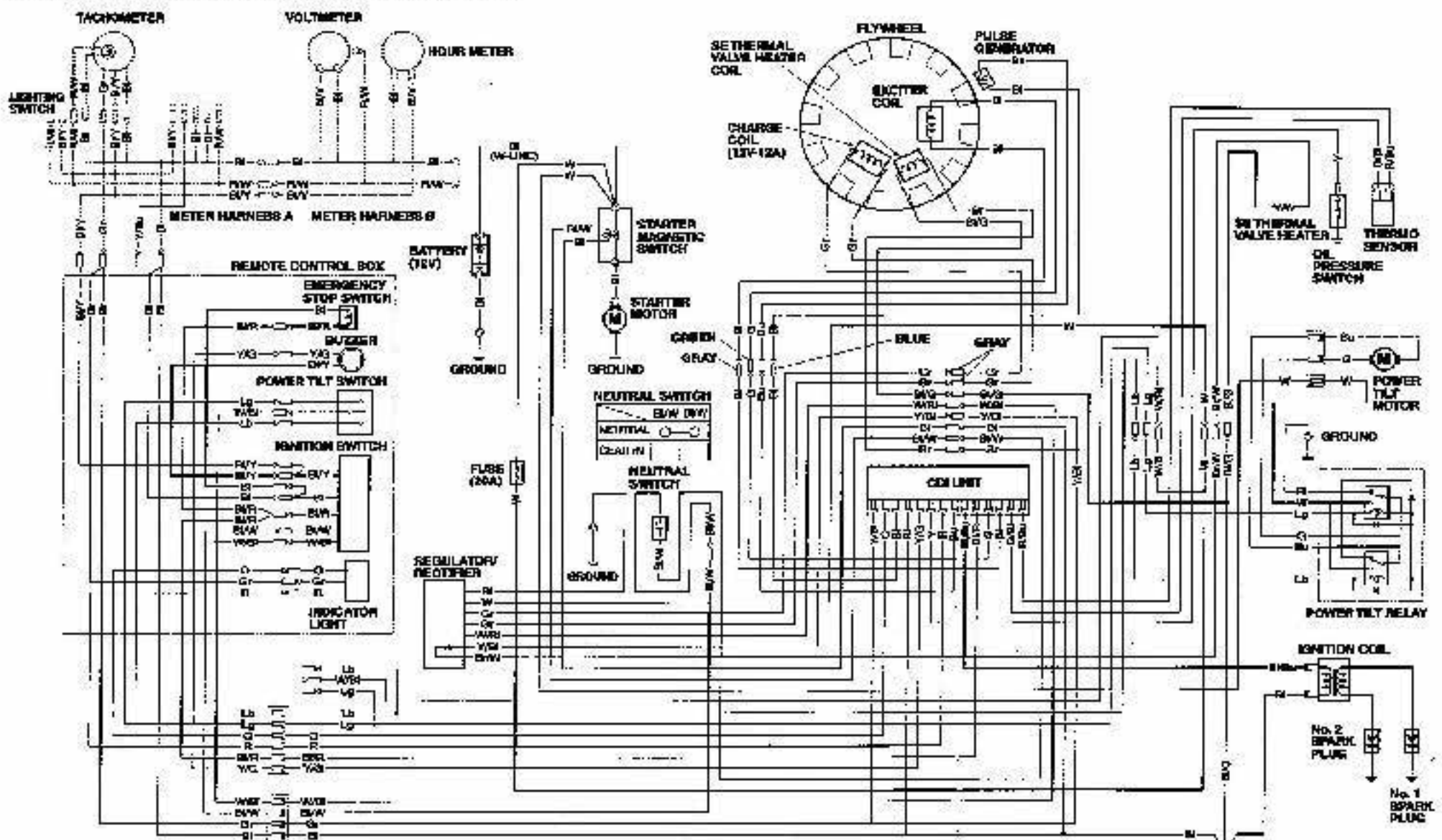

B	BLACK	B	BROWN
Y	YELLOW	GR	GREEN
BL	BLUE	LY	LIGHT BLUE
G	GREEN	Lg	LIGHT GREEN
R	RED	P	PINK
W	WHITE	SI	SILVER

HONDA

The power of dreams.

31ZY0600
00X31 ZY0 6000



AF 800.2002.06
Printed in Japan